

Dictionary-IV[®] Developer Guide



Version 8.7.1

285 Davidson Ave., Suite 302 • Somerset, NJ 08873-4153
Telephone: 732-560-1377 • Outside NJ 800-524-0430
Fax: 732-560-1594

Internet address: <http://www.tbred.com>

Published by:
Thoroughbred Software International, Inc.
285 Davidson Ave., Suite 302
Somerset, New Jersey 08873-4153

Copyright © 2011 by Thoroughbred Software International, Inc.

All rights reserved. No part of the contents of this document
may be reproduced or transmitted in any form or by any means
without the written permission of the publisher.

Document Number: DD8.7.1M101

The Thoroughbred logo, Swash logo, and Solution-IV Accounting logo, OPENWORKSHOP, THOROUGHbred, VIP FOR
DICTIONARY-IV, VIP, VIPImage, DICTIONARY-IV, and SOLUTION-IV are registered trademarks of Thoroughbred
Software International, Inc.

Thoroughbred Basic, TS Environment, T-WEB, Script-IV, Report-IV, Query-IV, Source-IV, TS Network DataServer, TS ODBC
DataServer, TS ODBC R/W DataServer, TS ORACLE DataServer, TS DataServer, TS XML DataServer, GWW, Gateway for
Windows™, TS ChartServer, TS ReportServer, TS WebServer, TbredComm, WorkStation Manager, Solution-IV Reprographics,
Solution-IV ezRepro, TS/Xpress, and DataSafeGuard are trademarks of Thoroughbred Software International, Inc.

Other names, products and services mentioned are the trademarks or registered trademarks of their respective vendors or
organizations.

LIBRARY MAINTENANCE

From the Dictionary-IV User Guide you see that the System Dictionary is central to Dictionary-IV. Within this System Dictionary, Dictionary-IV uses Libraries to organize and group Definitions or Classes (Formats, Screens, Views, Links, etc.).

Use Library Maintenance for changing, deleting, renaming, and copying libraries. You may also use Library Maintenance to create new libraries. However, Dictionary-IV allows you to create libraries directly from Definition Maintenance. For more information, see Class definition in this document.

The following options are available in Library Maintenance:

- Edit** Adds, changes, deletes, renames, and copies Libraries.
- List** Lists Library names and information about the Libraries to the terminal or printer.

Library Edit

Select **Library** from the Dictionary-IV Menu to display the Library View:

Libr Name	Description	Fmts	Scns	View	View	Link	Menu	Menu	Msgs	Help	Rpts	Qrys
4G	IDOL-IV 4GL	5	9	1	2	15	0	0	2	53	1	0
4S	4GL Sample Scripts	7	4	0	3	6	0	0	1	0	0	0
8D	BASIC On-line Help	7	5	1	12	6	0	0	1	535	0	0
8U	UNIX Utilities	0	0	0	0	0	0	0	0	302	0	0
GU	GUI Executive Vita	3	4	0	0	3	0	1	1	0	0	0
ID	IDOL-IV	132	136	45	56	102	0	3	5	1821	10	0
OE	OPENworkshp Examp1	13	14	22	9	17	0	0	1	65	8	2
OO	OPENworkshop	95	67	101	6	74	0	0	1	1023	7	0
Q4	QUERY-IV	17	13	3	6	9	0	0	2	69	5	38
QE	tsi:09-AUG-2007 14	0	0	0	0	0	0	0	0	0	0	2
SL	COO:27-JUL-2007 14	0	0	0	0	0	0	0	0	0	0	1

Use this view to change, delete, rename, or copy libraries. For more information about performing maintenance in a View or changing the appearance of a View, see CONNECT VIEW in the Dictionary-IV User Guide.

Field Descriptions

Library Name (Libr Name)

The Library name becomes the first two characters in the Class definition name and is used by the System Dictionary to organize Classes.

Type the 2 alphanumeric Library name and press **Enter**. The valid characters are numbers and upper and lowercase alphabetic characters.

Valid Library Name Characters

Class definition Name

--	--	--	--	--	--	--	--	--	--

Library Name

ABCDEFGHIJKLMNOPQRSTUVWXYZ
abcdefghijklmnopqrstuvwxyz
0123456789

Do not use Libraries that have the same name as any of the Thoroughbred Dictionary-IV based applications that you might install on your system.

Thoroughbred Dictionary-IV reserves the following Library names:

Reserved Dictionary-IV Library Names

4G 4S 8D 8S ID OE OO Q4 UT

If you install Solution-IV Accounting, you should not use the following Libraries:

Reserved Solution-IV Library Names

**AP AR BR CV FA FS GL IC IM OF OP PM PO PR
S4 TA UP ap ar br fa fs gl ic op po pr ta**

When setting up Libraries, it is best to select a Library name that will be easy to remember. You may wish to group Class definitions by:

- Application
- Individual
- Department

If you enter an existing Library name, the system displays the current information, which you may change, delete, rename, or copy. If you add a new Library enter the following header information.

Library Description

This is an optional entry used to identify the Library. Type up to 30 alphanumeric characters for the Library description and press **Enter**.

Contents

Displays the number of Definitions in each Class within an existing Library.

The contents include the number of Formats, Screens, OPENworkshop Views, Dictionary-IV Views, Links, OPENworkshop Menus, Dictionary-IV Menus, Messages, Help, Reports, and Queries.

Pwd

This is an optional entry used to restrict access to all definitions in the Library. System security must be active for the password to work. For information, see Operator Code Information in the Dictionary-IV Administrator Guide.

Last Change Date

Displays the date of the last change to the selected Library.

Create Date

Displays the date of creation of the selected Library.

Library Maintenance

You may add, change, rename, or delete Libraries from the Library View. For more information about performing maintenance from a View or changing the appearance of a view, see CONNECT VIEW in the Dictionary-IV User Guide.

Add/Change Library

Press **Line Insert** and type the Name and Description of a new Library. To change the Library Description, type over the existing Library Description.

Copy/Rename Library

Type over the existing Library Name and Press **Enter**. The system displays the following:

Definition	Copy	Rename
<Execute>		
<Toggle >	Yes	No
Formats	Yes	No
OOFS Views	Yes	No
4GL Views	Yes	No
Screens	Yes	No
Links	Yes	No
OOFS Menus	Yes	No
4GL Menus	Yes	No
Messages	Yes	No
Help	Yes	No
Reports	Yes	No
Queries	Yes	No

Select **<Toggle>** and press **Enter** to toggle all Class definitions. Select a specific Class definition and press **Enter** to toggle the individual Class definitions.

Selecting **Yes** copies/rename the Class definition. Selecting **No** does not copy/rename the Class definition. Select **<Execute>** to copy/rename the Class definitions.

Delete Library

Use this mode to delete part or all of an existing library. Press the **Line Delete** key. The system prompts:

Delete record?

Select **N** to exit the record without deleting. Select **Y** and the system displays the following:

Definition	Delete
<Execute>	
<Toggle >	No
Formats	No
OOFS Views	No
4GL Views	No
Screens	No
Links	No
OOFS Menus	No
4GL Menus	No
Messages	No
Help	No
Reports	No
Queries	No

Select **<Toggle>** and press **Enter** to toggle all Class definitions. Select a specific Class definition and press **Enter** to toggle the individual Class definitions.

Selecting **Yes** deletes the Class definition. Selecting **No** does not delete the Class definition. Select **<Execute>** to delete the Class definitions.

The system deletes the Library when you delete all Definitions within the Library.

If you are deleting Link definitions, you are given the option to delete the associated files. If you

select **Y** to delete the data file, you have the option to delete the sort file and text file.

If you are working in a Multi-Language environment the system prompts:

<Execute>		
<Toggle All>		
EN	English	X
FR	French	
GR	German	
IT	Italian	
SP	Spanish	
DU	Dutch	
SW	Swedish	
NR	Norwegian	
DN	Danish	
FN	Finnish	
X1	Other 1	
X2	Other 2	

Select <**Toggle All**> and press **Enter** to toggle all languages. Select a specific language and press **Enter** to toggle the individual language.

For more information, see Multi-Language in the Dictionary-IV Administrator Guide.

Select the language to delete and select <**Execute**>.

Library List

Use this function to list Libraries. The listing can display on the terminal or output to a printer.

If you are operating in a Multi-Language environment see Multi-Language in the Dictionary-IV Administrator Guide.

Select **5-List** from the Dictionary-IV Development Menu. The system prompts:

Do you want a printed copy?

Select one of the following:

Y The system asks for the printer name.

N The system displays the output at the terminal.

If you select to print, the system prompts:

Select printer (LP, P1, Pn):

LP, P1, Pn is the name of the printer.

For more information, see Printing in the Dictionary-IV User Guide. Type the name of the printer and press **Enter**. If security is active the system prompts:

To List Passwords, Enter the System Password:

You must enter the system password to obtain a listing that includes definition passwords.

Library Listing

```
LIBRARY LISTING
List all libraries? █ (Y/N)
from library.....:      (RETURN for first)
to library.....:        (RETURN for same or last)
using name mask..:      (RETURN to skip)
```

List all libraries?

Select one of the following:

Y Lists all Libraries. You cannot select a range or mask.

N Positions the cursor at the next field.

from library

Type the name of the first Library in the range to list and press **Enter**. The default is **First**.

to library

Type the name of the last Library in the range to list and press **Enter**. The default is **Last**. If you enter a name in the "from library" field and press **Enter** in this field, the system repeats the Library name. This allows you to list the definitions in one Library.

using name mask

Type from 1 to 2 alphanumeric characters for the mask to use. Then press **Enter**. The default is **None**.

The system prompts:

Is the displayed information correct?

Select one of the following:

Y Displays or prints the listing.

N Allows you to make corrections or exit without listing.

If system security is active and you enter the system password, you will see a Library Listing similar to the following:

Library Listing Sample

IDOL IV - LIBRARY LISTING												Page: 1	
												Date: 01/15/99	
Name	Description	Count	Frmt	Scrn	View	Link	Menu	Msgs	Help	Srpt	Rprt	Qury	00ww
Pswd	Owner												
=====													
4G	4GL Library	6	9	2	15	0	2	52	22	1	0	0	
	Thbred Software Int., Inc				08/28/98	10:04:48		12/19/89					
4S	4GL Sample Library	7	4	3	6	0	1	0	6	0	0	0	
					08/28/98	10:04:48		12/19/89					

CLASS DEFINITION

The System Dictionary allows you to create and maintain the following Class definitions: Formats, Screens, OPENworkshop Views, Links, OPENworkshop Menus, Messages, Help, Global Dictionary, Scripts, Reports, Library, Screens, Dictionary-IV Views, Dictionary-IV Menus, Query, Source, and System.

The following options are available for Class definition Maintenance:

- Edit** Adds, changes, deletes, renames, and copies Class definitions.
- List** Lists the Class type, name, description, password, creation date, last change date, and last change time to the terminal or printer.
- Print** Prints the Class type, name, description, password, creation date, last change date, and, last change time.

Definition Edit

Select **1-Edit** from the Dictionary-IV Development Menu or press **F1** at any Dictionary-IV menu.



Select the Class definition to maintain. The system displays the Class definition view. For more information about performing maintenance from the view or changing the appearance of a view, see CONNECT VIEW in the Dictionary-IV User Guide.

Components of Class Definition

Class definitions can be composed of three parts: header information, detail information, and editors.

Class Definition Header Information

There are common features in all Classes of definition maintenance.

[Class] Name

Contains from 3 to 8 alphanumeric characters for the name of a Class definition. This field is mandatory.

Characters one and two are the Library name. Characters three through eight are the Class definition name. For more information about guidelines, see Library Maintenance and Class definition Naming Guidelines.

[Class] Description

Contains from 1 to 40 alphanumeric characters for the description of this definition. This is an optional field.

Last Change Date

Displays the date of the last change to the selected Class definition.

Create Date

Displays the date of creation of the selected Class definition.

Class Definition Detail Information

The detail of a Class definition can come in the form of attributes or an editor window.

Attributes/Specifications

See each individual Class for descriptions of these attributes (specifications). In Format definition they include the length, entry type, valid entries, etc. for each Data Name. For more information, see the individual Class definition.

Editor Windows

Editor Windows allow you to enter text, position it in a window, and define display attributes (graphic/color). They include the Screen Editor, View Editor, Help Editor, Text Fields, and Source-IV Editor.

Class Definition Maintenance

For information on performing maintenance from a view or changing the appearance of a view see CONNECT VIEW in the Dictionary-IV User Guide.

Definition List

This function is used to list Class definitions. The listing can display on the terminal or output to a printer.

If you are operating in a Multi-Language environment see Multi-Language in the Dictionary-IV Administrator Guide.

Select **2-List** from the Dictionary-IV Development Menu. The system prompts:

Do you want a printed copy?

Select one of the following:

Y The system asks for the printer name.

N The system displays the output at the terminal.

If you select to print, the system prompts:

Select printer (LP, P1, Pn):

LP, P1, Pn is the name of the printer.

For more information, see Printing in the Dictionary-IV User Guide. Type the name of the printer and press **Enter**. If security is active the system prompts:

To List Passwords, Enter the System Password:

You must enter the system password to obtain a listing that includes definition passwords.

Definition Listing

Class Selector Message→

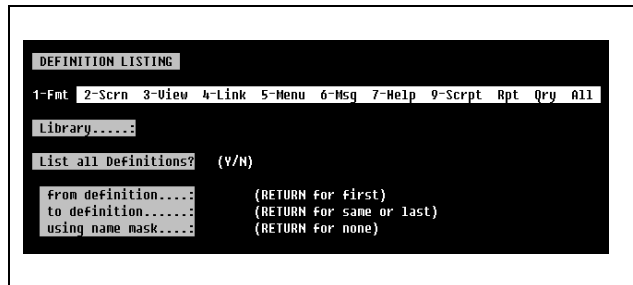

Enter the following information:

Class Selector message

Select the Class to list or type **A** for all Classes. Press **Enter**.

Library

Type the Library name for which you want a listing of definitions and press **Enter**.

List all definitions?

Select one of the following:

Y Lists all definitions. You cannot select a range or mask.

N Positions the cursor at the next field.

from definition

Type the name of the first definition in the range to list and press **Enter**. The default is **First**.

to definition

Type the last definition name in the range to list and press **Enter**. The default is **Last**. If you enter a name in the "from definition" field and press **Enter** in this field, the system repeats the Class definition name. This allows you to list the information for one definition.

using name mask

A name mask allows you to select Definitions without specifying individual names. It sets up a matching test. The system selects only those Definition names that match the mask.

Type from 1 to 6 alphanumeric characters for the mask to use. Then press **Enter**. The default is **None**.

A mask contains match and pass characters. The match character must match case and position exactly. The pass character (?) indicates there is no match in this position.

Mask	Action	Definition Names
MENU1?	Selects	MENU1 through MENU19
	Ignores	MENU2 through MENU99 menu2 through menu99 Menua through MENUZZ menua through menu zz

If you are operating in a Multi-Language environment the system prompts you through the languages. For more information, see Library Maintenance (Delete Library) in this document.

The system prompts:

Is the displayed information correct?

Select one of the following:

- Y** Displays or prints the listing.
- N** Allows you to make corrections or exit without listing.

The system then displays or prints the listing, which includes the following information.

Definition Listing Sample

```

IDOL-IV - DEFINITION LISTING                               Page: 1
Selected: Frmt                                           Date: 01/20/99
Library.: SL, tsi (01/22/98 15:32:59)
Password:      Owner: IDOL-IV Default Operator          Lst Chg Date: 08/28/98
Frmt Scrn View Link Menu Msgs Help Scpt Rprt Qury 00uw Created Date: 01/22/98
  2   1   0   1   1   0   3   1   0   0   1
-----
Type Name  Description----- Pwd  Created  --Last Changed--
-----
F  CUST  Sample Customer File          02/03/98 02/03/98 16:32:25
F  delete Sample Customer File      03/21/91 01/22/98 15:32:59

```

Press **F4** or **Enter** to exit the list. The system displays the definition listing screen so that you can select another listing.

Definition Print

Use this function is to print definition reports. Definition reports are copies of the actual definitions, containing all of the header, detail, and editor information. These reports are used primarily in design of definitions and as an aid for Definition Maintenance.

If you are operating in a Multi-Language environment see the Dictionary-IV Administrator Guide.

Select **3-Print** from the Dictionary-IV Development Menu. The system prompts:

Select printer (LP,P1, Pn):

LP, P1, Pn is the name of the printer.

For more information, see Printing in the Dictionary-IV User Guide. Type the name of the printer and press **Enter**.

Print Options for All Classes

Enter the following information:

Definition Report

Select the Class to list or type **A** for all Classes. Press **Enter**.

Library

Type the Library name for which you want definitions printed and press **Enter**.

Print everything?

Select one of the following:

Y Prints all definitions in the Library. You cannot select a range or mask.

N Positions the cursor at the next field.

from definition

Type the name of the first definition in the range to print and press **Enter**. The default is **First**.

to definition

Type the name of the last definition in the range to print and press **Enter**. The default is **Last**. If you enter a name in the "from library" field and press **Enter** in this field, the system repeats the definition name. This allows you to print one definition.

using name mask

Type from 1 to 6 alphanumeric characters for the mask to use. Then press **Enter**. The default is **None**.

For a description of using a name mask see Definition List in this document.

If you are operating in a Multi-Language environment the system prompts you through the languages. For more information, see Library Maintenance (Delete Library) in this document.

The system prompts:

Is the displayed information correct?

Select one of the following:

- Y** Prints the report or provides print options. For more information, see *Print Options by Class*.
- N** Allows you to make corrections or exit without printing.

Print Options by Class

Depending upon the report, the following print options are available:

- Summary or detail report.
- Print with on-line help documentation.
- Print with passwords.
- Definition-specific options.

If at any time you want to interrupt the printing, press the **Esc** key (on some systems, the **Del** key), and you will be asked if you want to interrupt the printing.

Formats

The system prompts:

S-Summary D-Detail

Select one of the following:

- S-Summary** Prints the report without the variable-length parameters (valid entries, default values, delete record, security, message, pre-processing, post-processing, and audit).
- D-Detail** Prints the report with the variable-length parameters.

The system then prompts (for both summary and detail):

Do you want to print on-line help documentation?

Select one of the following:

- Y** Prints the on-line help documentation associated with each Data Name.
- N** Does not print on-line help documentation.

The system prompts:

Print data-name descriptions: Selected languages

Select one of the following:

None Does not print the Data Name descriptions.

Selected languages Prints the Data Name descriptions.

The system prints the report to the selected printer.

Screens

The system prompts:

S-Standard **W-Windows**

Select one of the following:

S-Standard Prints the standard screens only (non-windows).

W-Windows Prints the window screens only.

If you are operating in a Multi-Language environment the system prompts you through the languages. For more information, see Library Maintenance (Delete Library) in this document.

The system then prompts (for both standard and window screens):

S-Summary **D-Detail**

Select one of the following:

S-Summary Prints the report without formulas and screen display codes.

D-Detail Prints the report with formulas and screen display codes. It also prints the associated link report and summary report.

The system prints the report to the selected printer.

Views

The system prompts:

S-Summary **D-Detail**

Select one of the following:

S-Summary Prints the view without the associated link report summary format report.

D-Detail Prints the report with the associated link report summary format report.

If you are operating in a Multi-Language environment the system prompts you through the languages. For more information, see Library Maintenance (Delete Library) in this document.

The system prints the report to the selected printer.

Links

The system prints the Links report to the selected printer.

Menus

The system prompts:

S-Summary D-Detail

Select one of the following:

S-Summary Prints the menu without the associated screen.

D-Detail Prints the report with the associated screen report.

The system then prompts (for both summary and detail):

Do you want to print on-line help documentation?

Select one of the following:

Y Prints the on-line help documentation.

N Does not print the on-line help documentation.

The system prints the report to the selected printer.

Messages

The system prompts:

1-Prompt/Constant 2-NonInput 3-Yes/No 4-Input
A-All

Select the type of message or **All** messages. The system prompts:

S-Summary D-Detail

Select one of the following:

S-Summary Prints the messages report without parameters and without the option for printing on-line help documentation.

D-Detail Prints the messages report with parameters and the option to print on-line help documentation.

If you are operating in a Multi-Language environment the system prompts you through the languages. For more information, see Library Maintenance (Delete Library) in this document.

The system prints the report to the selected printer.

Help

The system prompts:

S-Standard **W-Windows**

Select one of the following:

S-Standard Prints the help report for standard Help definitions (non-window).

W-Windows Prints the help report for window Help definitions.

If you are operating in a Multi-Language environment the system prompts you through the languages. For more information, see Library Maintenance (Delete Library) in this document.

The system prints the report to the selected printer.

Global Dictionary

The system prints the Global Dictionary report to the selected printer.

Script

The system prompts:

1-Primary 2-Cont 3-Overlay 4-FM Pre/Post 5-Copy 6-Public A-All

Select the type of script or **A-All** scripts. The system prompts:

INCLUDE Command Statements: Bypass Include

Select one of the following:

Bypass Does not merge INCLUDE scripts.

Includes Merges INCLUDE scripts into the report.

For more information, see the Script-IV Language Reference Manual.

The system prints the report to the selected printer.

Report

The system prompts:

Do you want to include formulas?

Select one of the following:

Y Prints any formulas that exist in the selected reports.

N Does not print formulas in the selected reports.

If you are operating in a Multi-Language environment the system prompts you through the languages. For more information, see Library Maintenance (Delete Library) in this document.

The system prints the report to the selected printer.

Query

If you are operating in a Multi-Language environment the system prompts you through the languages. For more information, see Library Maintenance (Delete Library) in this document.

The system prints the Query report to the selected printer.

Definition Naming Guidelines

File names consist of the Library Name and Definition Name.

Definition names may be from 3 to 8 characters long. Characters one and two are the Library name. Characters three through eight are the definition name.

The valid characters are numbers and upper and lowercase alphanumeric characters. For more information, see Library Maintenance in this document.

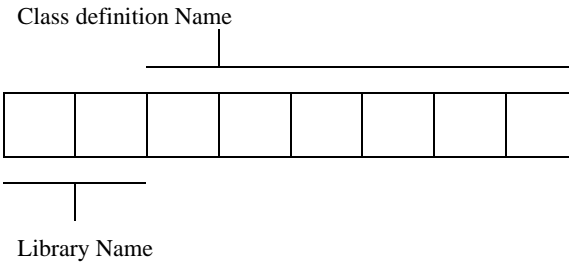

ABCDEFGHIJKLMNOPQRSTUVWXYZ
abcdefghijklmnopqrstuvwxyz
0123456789

Examples:

PL Incorrect – Must be at least 3 characters.

PLTEST> Incorrect – The > is not allowed.

PL Test Incorrect – The space is not allowed.

PL1 Correct

PLTEST Correct

PLTEST1 Correct – This name is different than pltest1.

All definition names within a Class are unique, but definitions in different Classes can have the same name.

Examples:

Format Class	Screen Class	View Class
ARCUMAS	ARCUMAS	ARCUMAS
ARPROS1	ARCUSADR	ARCUSADR
ARPROS2	ARPRSPCT	ARPRSADR

If you are going to develop a large application, it is strongly recommended that you develop naming conventions for your definitions. This consistency will help you identify and maintain definitions. You may wish to use the same, or a similar, name for definitions that are related.

If you enter a format name at database maintenance, the screen, view, link, and file names are automatically created for you with the same name as the format. This feature helps you to identify related database definitions by keeping the names the same.

It is also a good idea to reserve the last character of the name for numbering related definitions. For example:

Name	Description
MKFPMF1	Marketing: Prospect Master File Format
MKSPMF1	Marketing: Prospect Master File Screen
MKVPMF1	Marketing: Prospect Master File View
MKFPMF2	Marketing: Hot Prospects File Format
MKSPMF2	Marketing: Hot Prospects File Screen
MKVPMF2	Marketing: Hot Prospects File View
MKPPMF2	Marketing: Hot Prospects File Script
MKKFPWF1	Marketing: Prospect Work File Format
MKSPWF1	Marketing: Prospect Work File Screen
MKVPMF1	Marketing: Prospect Work File View
MKRPWF1	Marketing: Prospect Work File Report

Below is a naming convention you may wish to implement.

LLTNNNS

LL	specifies the Library name.
T	specifies the definition type (see below).
F	format
S	screen
V	view
L	link
M	message Dictionary
H	help
P	Script (Procedure)
Q	Query (Query-IV)
R	Report (Report-IV)
B	BASIC Program (3GL)

NNNN specifies the module name (definition descriptor).

S	specifies the definition suffix (see below).
0-9	Physical formats (for a data file). Physical screens (for screen Database Maintenance). Physical views (for view Database Maintenance).
A-Z	Logical formats (not associated with a data file).

Report Parameters.

Views used in the PRINT VIEW command in scripts.

Other Definitions not associated with a data file.

Note: A blank character is a valid character in path and file names.

FORMATS

Formats define the type of data and groupings of data you will store and the way you will store it. You must define a format for your data files, screens, and menus. There are two types of formats in Dictionary-IV:

- Physical
- Logical

Types of Formats

Physical

Physical formats are a template for a data file. They contain the header information (format name and description), the Data Names (field names for this record), and data name attributes (field length, default value, valid entries, or pre- and post-processing).

Format/Data File Relationship

Data File

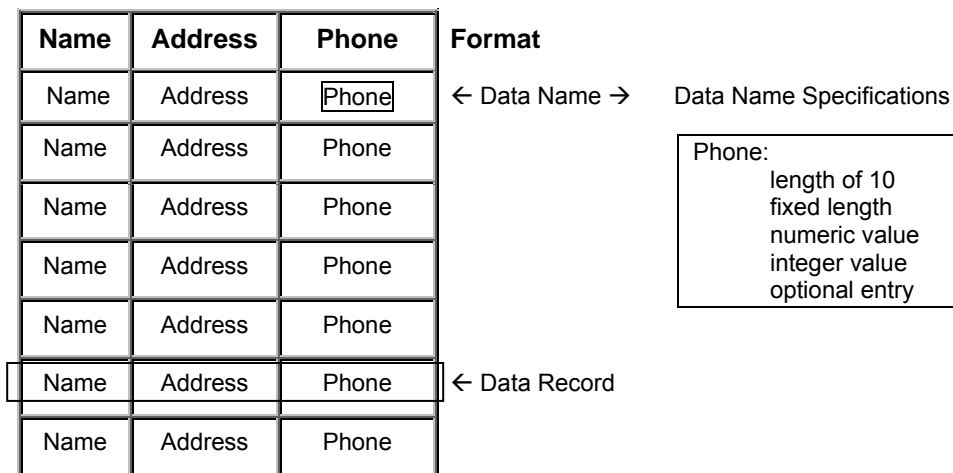

Logical

Logical formats are not linked to a data file. You use this type of format in a menu or to collect a data set that does not correspond to any single data file.

In menus, screens, or scripts a format can be used independently of a data file or link. In this usage it is referred to as a logical format and can function similar to data names or variables.

Formats for menus contain the header information (format name and description), only one Data Name (for the menu option selection field), and Data Name attributes (field length, default values, valid entries, or pre- and post- processing).

When you save and exit this format, do not create a data file.

For more information, see Menus in this document.

In a script you may assign a value to a logical format. This value can be printed or passed to another script and can be manipulated as an item of data in several Script-IV commands. For more information, see the Script-IV Developer Guide and the Script-IV Language Reference Manual.

Selection

From the Main Menu select **Dictionary-IV**.

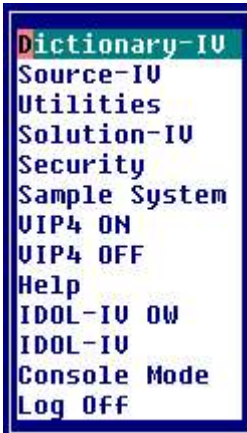

From the Dictionary-IV Menu select **Format**.



Select **Format**.

Format View

Format Name	Format Description	Key Len	Rec Len	Key Fld	T	Fld I Sep	LastChng Date	Create Date
UTCUST	Sample Customer File	4	127	1	Y	0	12/26/97	03/21/91
UTDELDNS	Convert Data Element Length -	21	33	2	N	0	03/21/90	03/21/90
UTDELLIB	Data Element Length Convert -	21	31	3	N	0	03/21/90	03/21/90
UTDIST	Sample Distribution File	4	59	1	N	0	02/23/95	02/23/95
UTFBPRM	IDOL-IV Sys Admin Basic PRM's	0	24	0	N	0	12/08/95	12/07/95
UTFGGLBD	Global Element Dictionary	18	101	2	N	8	08/18/92	08/17/92
UTFCNVT	IDOL to IDOL IV Conversion Fil	37	37	4	N	0	08/18/92	08/17/92
UTFCSTM1	IDOL-IV User Customization - S	0	24	0	N	0	07/16/93	07/07/93
UTFHELPT	Help Topic Format	66	66	4	N	0	01/06/95	03/30/94
UTFFORMAT	IDOL IV - Format Definition	9	96	2	N	0	12/09/88	10/19/84
UTFTEXT	Format to Use in TEXT Files	0	1031	0	N	1	05/25/93	05/25/93

Components of Format View

The Format definition is composed of three parts: header information, Data Names, and Data Name attributes.

Format View Header Information

This displays the format name, description, key length, record length, key field, text field flag, field separators, last change date, and creation date.

Format Name

From 3 to 8 alphanumeric characters for the name of this format. This field is mandatory.

Characters one and two are the Library name. Characters three through eight are the format name. If the Library does not exist the system will allow you to create it here.

For more information, see Class definition in this document, which provides a file naming convention.

The following unique function keys are available from the Format Name Field:

F1 Allows you to edit the Format.

Fld Num	Data Name	Field Size	Y	S	Code	K	F	Help	Y	P	D	N	E	U	D	S	M	B	A	A
1	CUST-CODE	4			Y N				N	0	0	0	0							
2	CUST-NAME	30			N N				N	0	0	0	0							
3	ADDRESS	20			N N				N	0	0	0	0							
4	CITY	20			N N				N	0	0	0	0							
5	STATE	2			N N				N	0	0	0	0							
6	ZIP-CODE	10			N N				N	0	0	0	0							
7	PHONE	10			N N				N	4	0	0	0							
8	REP-CODE	3			N N				N	0	0	0	0	X						
9	TERMS	1			N N				N	0	0	0	0	X						
10	CREDIT-LIMIT	6.0			N N				N	0	0	1	0							
11	CREDIT-COMMENTS	1			N N				N	6	0	0	0	X						
12	OPEN-AR-BALANCE	10.2			N N				N	0	0	0	0							
13	YTD-SALES	10.2			N N				N	0	0	1	0							X

While the cursor is in the Field Number you may select from the following:

F2 Lookup Global.

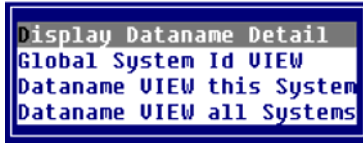

For more information, see Global.

F3 Move When you press F3 the system prompts:

Enter move command (xxyy or xx,yy):

Type the Field Number you want to "move from" then type the Field Number you want to "move to". The system moves the Data Name and attributes in front of the "move to" Field Number. For example: if you type **1,5** and press **Enter** the system moves the Customer Code and all of its attributes to Field Number 4.

You will be prompted to **Save modifications** when you exit.

F5 Swap When you press F5 the system prompts:

Enter swap command (xxyy or xx,yy):

Type the Field Number you want to "swap" then type the Field Number you want to "swap with". The system swaps the Data Name and attributes you type. For example: if you type **1,5** and press **Enter** the system moves the Customer Code and all of its attributes to Field Number 5 and State and all of its attributes to Field Number 1.

You will be prompted to **Save format modifications** when you exit.

F7 Multi-Language Data Descriptions Displays a view similar to the following:

Multi-language data descriptions			
Data Element	English Description	French Description	German Description
P-LIB-NAME			
CP-ALL			
CP-FROM			
CP-TO			
CP-MASK			

Here you may define the descriptions to be displayed for each Data Name in the Format. If you are operating in a Multi-Language environment, you may define the language descriptions for each Data Name. For more information, see Field Descriptions in this document. For more information on the Multi-Language environment see Multi-Language in the Dictionary-IV Administrator Guide.

F2 Displays the Format. From this window you can Press **F7** and the system displays the following pop-up menu:

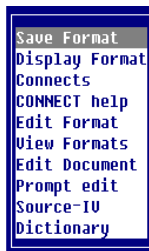

From here you can save the format, display the format, display Data Names that have CONNECT directives, display CONNECT help, edit the format, display the Formats view, edit a text document, CONNECT to Source-IV, or CONNECT to Dictionary-IV.

Format Description

Type up to 40 alphanumeric characters for the description of this format. This field is optional.

Key Length (Key Len)

No input is required. To change this field you should press **F1** and edit the Format. Displays the length of the Key fields in the format.

Record Length (Rec Len)

No input is required. To change this field you should press **F1** and edit the Format. Displays the length of the entire format (excluding the field separators).

Key Field (Key Fld)

No input is required. To change this field you should press **F1** and edit the Format. Displays the number of primary key fields in the format.

Text Field Flag (TI)

No input is required. To change this field you should press **F1** and edit the Format. Displays **Y** if there are text fields displayed in the format. Displays **N** if there are no text fields displayed in the format.

Field Separators (Fld Sep)

No input is required. To change this field you should press **F1** and edit the Format. Displays the number of field separators in the format.

Last Change Date

This field is automatically calculated. No input is required. Displays the date of the last change to the selected format.

Create Date

This field is automatically calculated. No input is required. Displays the date of creation of the selected format.

Field Descriptions: Data Names

The Data Name list displays all Data Names in the format. Although only a limited number may be shown at a time, you may create up to 255 Data Names. To view the data names not appearing on the screen, press **F10** (Goto Data Name) or use the **Up Arrow**, **Down Arrow**, **Page Up**, and **Page Down** keys.

The order in which these Data Names display is the order in which they display on the default screen and view. For more information, see Screens and Views in this document.

If you are using TS ORACLE DataServer you may create only 254 Data Names.

Field Number (Fld Num)

Displays the number of the Data Name. Each Data Name has a unique Field number.

Data Name

From 1 to 20 alphanumeric characters for the name of this Data Name in the format. You must define at least one Data Name.

In a data file this Data Name represents a field in a record.

In a menu you must define one Data Name, which has the length equaling the largest selection code on the menu. For more information, see Menus in this document.

Add, change, or delete Data Names using normal View maintenance procedures. For more information, see CONNECT VIEW in the Dictionary-IV User Guide.

You may also press **F8** and the system displays the Global Dictionary.

Global DN View			
Data Name	Sys K		Format
	Id	y	
UST-ADDRESS	0E	-	0EFCUST
CUST-ADDRESS	0E	-	0EFCUSTX
CUST-CITY	0E	-	0EFCUST
CUST-CITY	0E	-	0EFCUSTX
CUST-CODE	0E	Y	0EFCUST
CUST-CODE	0E	Y	0EFCUSTX
CUST-CODE	0E	-	0EFINUD
CUST-CODE	0E	-	0EFINUH
CUST-COMMENTS	0E	-	0EFCUST
CUST-COMMENTS	0E	-	0EFCUSTX
CUST-CONTACT	0E	-	0EFCUST

This is a view of all Data Names generated using the Global Systems Definitions. For more information, see Global Systems Definition in this document.

It lists all Data Names showing the System ID and the Format definitions where that Data Name is used. Select a Data Name. Press **F1** or **F2** to display the attributes for that Data Name. Press **Enter** to select the Data Name.

Field Descriptions: Data Descriptions

Press **F7** in the Field Number field to access Multi-Language descriptions.

Multi-Language Data Descriptions

Multi-language data descriptions			
Data Element	English Description	French Description	German Description
SCRIPT	Script		
SEQUENCE	Sequence		
PROCEDURE	Procedure		
DESCRIPTION	Description		

You can enter a description for each Data Name or press **F11** to generate default Data Descriptions based on the Data Name. When displaying the Data Name view, the descriptions display in the current language. These descriptions can be up to 20 characters and can contain special characters (such as spaces) not supported in Data Names.

Note: an error window will report when you enter a duplicate data description.

Maintenance of the Data Descriptions is done using an OPENworkshop View. This allows you to delete and arrange the columns in a convenient format. The view size and location may be changed. Rows cannot be deleted or added.

For more information, see Multi-Language in the Dictionary-IV Administrator Guide and CONNECT VIEW in the Dictionary-IV User Guide.

Field Descriptions: Data Name Attributes

This information defines the attributes for each Data Name. Press **F1** in the Format Name field to edit the format. The system displays the following:

Format Editor

Fld Num	Data Name	Field Size	K	F	Help	Y	P	D	N	E	U	D	S	H	B	A	A
			V	S	Code	N	D	T	T	T	U	E	R	C	S	P	P
1	CUST-CODE	4	Y	N		N	0	0	0	0							
2	CUST-NAME	30	N	N		N	0	0	0	0							
3	ADDRESS	20	N	N		N	0	0	0	0							
4	CITY	20	N	N		N	0	0	0	0							
5	STATE	2	N	N		N	0	0	0	0							
6	ZIP-CODE	10	N	N		N	0	0	0	0							
7	PHONE	10	N	N		N	4	0	0	0							
8	REP-CODE	3	N	N		N	0	0	0	0							X
9	TERMS	1	N	N		N	0	0	0	0							X
10	CREDIT-LIMIT	6.0	N	N		N	0	0	1	0							
11	CREDIT-COMMENTS	1	N	N		N	6	0	0	0							X
12	OPEN-AR-BALANCE	10.2	N	N		N	0	0	0	0							
13	YTD-SALES	10.2	N	N		N	0	0	1	0							X

Note: When you update your format definitions, a window displays containing a list of screen definition names and formulas that have generated a syntax error.

This window only appears if there are problems compiling formulas. This is done whenever a format is changed in such a way that it would affect the screen (definition name length, deleting a definition name, etc.). This window will show you which formulas had problems. If it doesn't appear, the formulas were recompiled successfully.

Field Size

Specifies the maximum length of this Data Name, whether you may enter numeric or alphanumeric data, and whether or not there are multiple occurrences of this field.

By specifying the occurrences you can define a table of Data Names that share a common name and definition. The length of a numeric Data Name depends upon the numeric type defined for this Data Name. For more information about numeric types see the Numeric Type field definitions later in this section.

This field is mandatory.

Field Size - Alphanumeric

n

n is an integer from 1 to 255. This determines the length of an alphanumeric field.

Example:

35

Defines a string field of 35 characters.

Field Size - Alphanumeric Repeating Fields (Multiple Occurrences)

$n_1 * n_2, FS$

n_1 is the length of the alphanumeric Data Name.

n_2 is the number of occurrences from 1 to 32767.

FS (optional) places a field separator between each occurrence. Field Separator (FS).

Example:

6*5,FS

This entry specifies a six character alphanumeric input repeated 5 times. A field separator is placed between each occurrence.

Field Size - Numeric (General)

Guidelines to Calculate Numeric Data Name Length

Data Name length refers to the physical storage of a number. Numbers using ASCII storage (numeric types 0, 1, and 2) will use the same number of characters to store the number. These numbers may also store one place for a sign +/- numeric types 0 and 2, and one place for a decimal point.

Numbers using a binary storage function (numeric types above 2) will typically require less storage space. The Data Name length would be determined based on binary storage method.

Field Size - Numeric: Fixed Point

$n_1 \cdot n_2$

For numeric types 0 and 2:

n_1 is the total number of characters in the field and may be from 2 to 16 characters. Include one for the sign (+/-) and one for the decimal point.

n_2 is the number of positions in the decimal portion of the Data Name. Precision zero must be specified.

For numeric type 1:

n_1 is the total number of characters in the field and may be from 1 to 15 characters. Include one for the decimal point.

n_2 is the number of positions in the decimal portion of the Data Name. Precision zero must be specified.

Example:

8.2

Defines a numeric field. The size and format of this field depends on the numeric type.

Field Size - Numeric: Binary Data

$n_1.n_2$

For numeric types 3, 4, and 5:

n_1 is the total number of characters in the field and may be from 1 to 8.

n_2 is the number of positions in the decimal portion of the Data Name. Precision zero must be specified.

Use the following as a general guide to determine the length for these numeric types:

$$\text{Disp Size} = (\text{Storage Size} * 2) + 1 + S + D$$

S is the sign.

D is the decimal.

For numeric types 3 and 5, S=1 for the sign. When precision > 0, D= 1 for the decimal point.

When displaying a number with more than 14 digits, the display will be in exponential form.

For more information on binary storage, see the BIN function in the Thoroughbred Basic Reference Manual.

Field Size - Numeric: Packed Data

$n_1.n_2$

For numeric type 6:

n_1 is the total number of characters in the field and may be from 1 to 6.

n_2 is the length of the decimal portion of the element. Precision zero must be specified.

Use the following as a general guide to determine the length for this numeric type:

$$\text{Disp Size} = (\text{Storage Size} * 2) - 1 + S + D$$

S is the sign.

D is the decimal.

When precision > 0, D = 1 for the decimal point.

For more information on PACKed storage, see the PCK function in the Thoroughbred Basic Reference Manual.

Field Size - Numeric: Informix Data

$n_1 \cdot n_2$

For numeric type 7:

n_1 is the total number of characters in the field and may be from 2 to 9.

n_2 is the length of the decimal portion of the Data Name. Precision zero must be specified.

Use the following to determine lengths:

S is the sign.

D is the decimal.

Storage Size	Display Size
2	2 + S + D
3	4 + S + D
4	6 + S + D
5	8 + S + D
6	10 + S + D
7	12 + S + D
8	14 + S + D

When precision > 0, D = 1 for the decimal point.

Field Size - Numeric: IEEE Data

Storage of IEEE numerics are hardware architecture dependent. They may or may not be transportable across different platforms. For example, INTEL and Motorola are mirror images, therefore IEEE data fields must be converted when moving files from one platform to the other.

$n_1 \cdot n_2$

For numeric type 8:

n_1 is 4.

n_2 is the length of the decimal portion of the element. Precision zero must be specified.

For numeric type 9:

n_1 is 8.

n_2 is the length of the decimal portion of the element. Precision zero must be specified.

$$\text{Disp Size} = \text{Storage Size} + S + D$$

S is the sign.

D is the decimal.

S = 1 for the sign. When precision > 0, D = 1 for the decimal point.

Field Size - Numeric: BCD Data

$n_1 \cdot n_2$

For numeric types A and B:

n_1 is the total number of characters in the field and may be from 1 to 8.

n_2 is the length of the decimal portion of the element. Precision zero must be specified.

Numeric Type A:

$$\text{Disp Size} = (\text{Storage Size} * 2) - 1 + S + D$$

Numeric Type B:

$$\text{Disp Size} = (\text{Storage Size} * 2) - 1 + D$$

S is the sign.

D is the decimal.

S = 1 for the sign. When precision > 0, D = 1 for the decimal point.

For numeric type C:

n_1 is the total number of characters in the field and may be from 1 to 7.

n_2 is the length of the decimal portion of the element. Precision zero must be specified.

Numeric Type C:

$$\text{Disp Size} = (\text{Storage Size} * 2) - 1 + D$$

S is the sign.

D is the decimal.

S = 1 for the sign. When precision > 0, D = 1 for the decimal point.

Field Size - Numeric: ASCII Data

n₁ . n₂

For numeric type D:

n₁ is the total number of characters in the field and may be from 1 to 14.

n₂ is the length of the decimal portion of the element. Precision zero must be specified.

For numeric types E and F:

n₁ is the total number of characters in the field and may be from 2 to 15. Include 1 for the sign (+/-).

n₂ is the length of the decimal portion of the element. Precision zero must be specified.

Field Size - Numeric Repeating Field (Multiple Occurrence)

n₁ [. n₂] * n₃ , FS

n₁.n₂ is the length of the numeric Data Name.

n₃ is the number of occurrences from 1 to 32767.

FS (optional) places a field separator between each occurrence. For more information, see Field Separator (FS).

Example:

8.2*5,FS

This entry specifies a numeric input repeated 5 times. A field separator is placed between each occurrence.

Key (KY)

Specifies whether or not this Data Name is a primary key field.

Select one of the following:

Y This Data Name is a key or part of the key.

N This Data Name is not a key field.

The default is **N**.

When the File Type in the corresponding Link Class is set to **I** (Dictionary-IV file type), the Key Indicator is used to determine the file type according to the following chart:

Data Names as Key	Type of Data File
None	Index, Text
Some Keys	Direct, MSORT, TISAM
All Key	Sort

Sorts (cross-indexes or secondary keys) are created from link maintenance.

The Key Indicator can be set for any Data Name in the format. If the key fields are not contiguous, create a SORT0 definition in the link to describe the primary key.

The script directive below collects input from all fields, which have the Key Indicator set to **Y**. The system prompts:

INPUT SCREEN screen-name KEY

Field Separator (FS)

Specifies a field separator to be placed at the end of this Data Name. This treats the next Data Name internally as a separate field.

Select one of the following:

Y Add a field separator after the Data Name.

N Do not add a field separator after the Data Name.

A field separator is a special character (\$8A\$) that follows the Data Name in the record.

One character is added to the file's record size for each field separator. You can control which character is used as a field separator. For more information see PRM and SEP in the Thoroughbred Basic Reference Manual.

This is important when developing a format for an existing data file, but optional when creating a new format.

The default is **N**.

You cannot use field separators with any binary storage. For more information, see PRM and SEP in the Thoroughbred Basic Reference Manual. For example, SQL dates are stored in binary form. If you must use field separators, then the date fields cannot be SQL date types.

Help Code

From 1 to 6 alphanumeric characters for the name of the module to be displayed for this Data Name. You do not need to include the library name. The system automatically places this Help definition in the library used by this Format. This field is optional.

This module is the Help definition that displays when you initiate help (press **F6**) at this Data Name during database maintenance. You may enter an existing help module or create a new one.

Press **Enter** to continue to the next field or press **F1** to create help text.

For more information, see Help in this document.

After making your selection, you may enter your help text, then press **F4**. The system prompts:

Save Text?

Select one of the following:

- Y** Saves the changes and returns to the current definition.
- N** Allows you to make corrections.
- S** Saves text and returns to the help text editor.

If the operator is defined as a developer, help text may be created here or from database maintenance. When the help is displayed press **F1** from the help window to perform the edit. For more information, see Set Developer/User in the Dictionary-IV Administrator Guide.

Yes/No (Y/N)

Creates a Data Name that accepts yes or no input.

Select one of the following:

- Y** Accepts only the input **Y, y, N, n**.
- N** This is not a yes/no field and input is not limited to **Y, y, N, n**.
- blank** This is used if the input type is optional.

The Yes/No indicator defines the valid entry to be a Y (yes) or N (no) response. Y automatically sets the Length field to 1.

The default is **N**.

Pad (PD)

Defines the leading and trailing characters to be used in variable length fields. It also defines the format of telephone numbers, social security numbers, and text fields. Padding is independent of whether a field is numeric or alphanumeric.

The padding can be either spaces or zeros placed before or after the input.

Select one of the following:

- 0** Left justifies data with trailing spaces.
- 1** Right justifies data with leading spaces.
- 2** Left justifies data with trailing zeros.
- 3** Right justifies data with leading zeros.
- 4** Telephone number format. Automatically sets the Length field to 10 and makes this a fixed length field. Provides the following format: 000 000-0000.
- 5** Social security number format. Automatically sets the Length field to 9 and makes this a fixed length field. Provides the following format: 000-00-0000.
- 6** Text field. Automatically sets the Length field to 1.

The default is **0**.

Date (DT)

The date type defines the format of a date; where DD = day, MM = month, YY = year, and CC = century. Select one of the following:

- 0 Not a date.
- 1 MMDDYY Automatically sets the Length field to 6 and makes this a fixed length field.
- 2 YYMMDD Continues the counting pattern using alpha characters. A0 follows 99 and B0 follows A9. This date type requires a PRM BASE-YEAR. For more information on BASE-YEAR, refer to the Thoroughbred Basic Customization and Tuning Guide Volume II. The BASE-YEAR= parameter is used to specify the base year for 00. Typically, this value is either 1900 (default) or 1800. The following table shows the storage of the year for both 1800 and 1900 base.
- 3 DDMMYY Automatically sets the Length field to 6 and makes this a fixed length field.
- 4 YYDDD (Julian Calendar) Automatically sets the Length field to 5 and makes this a fixed length field.
- 5 SQL Automatically sets the Length field to 6 and makes this a fixed length field. For more information, see Entry Type. SQL dates cannot have a field separator. For more information, see Field Separator (FS).
- 6 MMDDCCYY Automatically sets the Length field to 6 and makes this a fixed length field.
- 7 CHR(YY+1) allows the storage of years up to 99. See the storage formula below:

```
from:   CHR (YY+1) +CHR (MM+1) +CHR (DD+1)
to:     CHR (MOD(YYYY,1900)+1)+CHR (MM+1)+CHR (DD+1)
```

The new date type 7 formula supports both 2 and 4-character years. But as a compressed date, it will eventually generate a binary value that may be misinterpreted. Using this technique, the year 2037 is stored as a field separator (\$8A\$)MMDDYY Automatically sets the Length field to 3 and makes this a fixed length field.

- 8 MMDDYYYYY Date type 8 stores Thoroughbred Basic SQL data as a number in your data files This eliminates the problems caused by binary storage found with Date Type 5.

Date type 5 is stored as a 6-byte binary field, but the definition length is 6 and the numeric type is 0. This stores date and time. To store just the date, set the length to 4 and the numeric type to 0. When date type 5 is stored in 4 bytes, the result is an Informix compatible SQL date.

To convert from:	Use:
A numeric SQL date to a 6 byte binary format	PRECISION 4; DATE\$=BIN(INT(ND*10000),6)
A numeric SQL date to a 4 byte binary format	DATE\$=BIN(ND-693597,4)
A 6 byte binary field to a numeric SQL date	PRECISION 4; ND=DEC(DATE\$)/10000
A 4 byte binary field to a numeric SQL date	ND=DEC(DATE\$)+693597

Precision 4 produces an SQL date with time to within + or - 9 seconds. On average the time will be accurate to within + or - 5 seconds. If a more accurate time stamp is required, the TIM function in Thoroughbred Basic should be used, or a combination of an SQL date and a sequence number.

Date type 6 is stored as CHR(CC) + CHR(Y Y) + MMDD.

Date type 7 is stored as CHR(Y Y+1) + CHR(MM+1) + CHR(DD+1). For more information on CHR, see the Thoroughbred Basic Reference Manual.

Date type 8 is MMDDYYYY and stored as a string and supports the following lengths:

5.4, 6.5, 8.7, 9.8, 12.5, 13.6, 14.7 and 15.8.

Note: Date Types 2 and 7, while providing a quick fix, still rely on data compression and/or logical interpretation of data. Thoroughbred Basic has long supported a date type suitable for YEAR 2000 development. The SQL date is an industry accepted Y2K solution providing automatic functions for sorting, compares, arithmetic and storage. The Thoroughbred Basic SQL date is now available to Dictionary-IV developers in a new date type. The new date type stores the Thoroughbred Basic SQL date as a decimal number. The format storage length depends on whether you require time.

The input and display for the updated and new date types are determined by Global variables. The input and display can be a combination of 6 and 8-character formats. If an application's dates are not ambiguous in regard to century, displaying 6 may be sufficient. The Global variables also provide for specification of a Date Method. The Date Method provides the opportunity to modify the users input prior to date validation. The most common use of the Date Method is to determine and add a Century value to a 6-character date. For example; the user enters 082859 and the input mask is set to MMDDYYYY. Normally, a date validation routine would fail this input. The mask is 8-characters but the user only entered 6. With Date Methods, your application can now supply the missing information prior to validation by adding the proper century value. The Date Method has access to all kinds of information to assist in determining the Century including the dates, data-names, format and link names. Thoroughbred provides a sample Date Method that replicates the Thoroughbred Basic sliding 50-year rule to determine the century. The method can be maintained as either a Thoroughbred Basic program or an OPENworkshop script method. This method is provided to help assist developers in providing a solid Y2K solution.

If you previously selected a padding type for a telephone number, social security number, or text field, the system automatically enters the default value of 0 in these fields.

During file maintenance the system automatically tests for input of valid date values. If the Data Name is mandatory and you press **Enter**, the system displays the current date in the selected format.

Numeric Type (NT)

Specifies the storage method and the types of numbers that are accepted as valid input to a numeric Data Name.

Select one of the following:

- 0** Fixed point positive/negative
- 1** Fixed point positive
- 2** Fixed point negative
- 3** Binary storage positive/negative
- 4** Binary storage positive
- 5** Binary storage negative
- 6** Packed storage positive/negative
- 7** Informix Decimal compatible storage
- 8** IEEE single precision compatible storage
- 9** IEEE double precision compatible storage
- A** Binary Coded Decimal signed compatible storage
- B** Binary Coded Decimal unsigned compatible storage
- C** Binary Coded Decimal no sign compatible storage
- D** ASCII sign masked storage
- E** ASCII leading byte sign storage
- F** ASCII trailing byte sign storage

The floating-point types include decimal, integer, and exponential values (more than 14 positions).

Numeric types 3, 4, 5, 6, A, B, C, D, E, and F imply a decimal. The decimal value is not stored but calculated for input or output based on the precision defined in the Data Name length field.

For storage: $\text{number} = \text{number} * 10 ^ \text{precision}$
 12.34 = 1234

For display: $\text{number} = \text{number} / 10 ^ \text{precision}$
 1234 = 12.34

The default is **0**.

Entry Type (ET)

Specifies whether the input of the Data Name is optional or mandatory and of variable or fixed length.

Select one of the following:

- 0** Optional entry, variable length. The number of characters you may enter for this Data Name range from 0 to the number of characters specified in the Length field. The system pads with spaces or zeros. For more information, see Pad (PD).
- 1** Optional entry, fixed length. You do not have to make any entry in this field, if you do, it must be the exact number of characters specified in the Length field. The system will not pad with spaces or zeros.
- 2** Required entry, variable length. The number of characters you may enter for this Data Name range from 1 to the number of characters specified in the Length field. The system pads with spaces or zeros. For more information, see Pad (PD).
- 3** Required entry, fixed length. You must make an entry in this field and it must be the exact number of characters specified in the Length field. The system will not pad with spaces or zeros.

The default is **0**.

Valid Values (VV)

Defines valid values, provides text field specifications, and SQL input and display masks. Valid entries may be listed individually, by range, by file name, or by view name.

Make sure the valid values you provide have the correct length defined for this Data Name.

Press **Enter** to define Valid Values.

Valid Values: List

Specifies a list of valid values. The maximum list length is 255 characters. Entries must be separated by commas.

0, val-1[, val-2...] [:trans-val-1,trans-val-2...]

0 specifies a valid entry list.

val-1 is a valid entry for this Data Name.

val-2 (optional) is another valid entry for this Data Name.

trans-val-1 (optional) is a value into which val-1 is converted. Val/trans-val sets must match in number values and total length.

trans-val-2 (optional) is a translation value for val-2.

Examples:

0,HRD,BB ,SFT,MFR,Z , STK

The valid values are HRD, BB, SFT, MFR, Z, STK for a Data Name with a length of 3 and padding type 0 (left justify and fill with spaces).

0,A,B,C:1,2,3

The valid values are A (which returns a value of 1), B (which returns a value of 2), and C (which returns a value of 3). The translation value is stored in the data file.

Valid Values: Range

Specifies a range of valid values. This test does an entire string comparison. Alphanumeric values will fall within a numeric range check on alphanumeric Data Name.

The maximum list length is 255 characters. Entries must be separated by commas; ranges by semicolons.

1,lo-val-1,hi-val-1[;lo-val-2, hi-val-2]...

1 specifies a valid entry range.

lo-val-1 is the lowest value in the first range.

hi-val-1 is the highest value in the first range.

lo-val-2 (optional) is the lowest value in an additional range.

hi-val-2 (optional) is the highest value in an additional range.

Examples:

1,5500,6599;7500,8599

The valid values are 5500 through 6599 and 7500 through 8599.

1, A12, A56;B1 ,B9

The valid values are A12 through A56 and B1 through B9 for a Data Name with a length of 3 and padding type 0 (left justify and fill with spaces).

Valid Values: File Lookup

Specifies a lookup file containing valid values, which are primary keys of the data file. If a matching key is found, the operator input is considered valid.

An optional prefix can be placed on the entered value if more than one list of valid values is in the file. When the input is validated, the data associated with the key in the lookup file can be transferred into a variable and used for special processing. You must write a special program to use this ability.

2,lookup-link,read-opt [, "prefix"]

2 specifies a file lookup of valid entries.

lookup-link is the name of the Link that specifies a physical file containing the lookup values. If the file is not found an error message is displayed.

read-opt is one of the following:

0 performs the lookup but no data read into S\$ for processing.

1 if valid, read data into variable S\$ for processing. Data is obtained using EXTRACT RECORD. The record will be locked.

"prefix" (optional) is the prefix attached to the entry before lookup. It must be placed in quotation marks.

If the format will be used in a script, use read-option 0.

Example:

2,PLLOOK1B,0,"A"

The valid values are in the file named PLLOOK1B. If the entry is valid, no data will be read into S\$. A prefix of A will be attached to the entered values before lookup.

Valid Values: Lookup View

Specifies a view containing valid values, which are the primary keys of the data file. If a valid value is not found, the system displays the view you specify. You may scroll the listing and press **Enter** to select a valid value from this view.

LOOKUP VIEW view-name[ERMFIRST | SPACEOK | PVIEW]

LOOKUP VIEW is the keyword.

view-name is the view name to lookup.

ERMFIRST indicates that an error message will be printed prior to the view. Press **F4** to return to the operator input. Any other response will display the LOOKUP VIEW.

SPACEOK indicates that blank entries will not display the LOOKUP VIEW.

PVIEW indicates that the view will function as a PRINT VIEW. No data changes are allowed. Press **Enter** to select the record and press **F4** to exit the view with no data returned.

Example:

LOOKUP VIEW UTVCUST

The valid values are in the link used by the view, UTVCUST. If an entry is not valid, the system displays the view UTVCUST.

Valid Values: Text Field Window

Text fields are used for storing unlimited amounts of text that may vary in size from one record to another. When you set up a text field window, the system automatically sets the Length field to 1 and Pad field to 6.

The text is entered into a window and can be edited using a full screen Text Editor. For more information, see Text Editor in the Dictionary-IV User Guide.

You can have more than one text field in a format.

The data file must be an Dictionary-IV Direct, MSORT, or TISAM file. This adds 4 to the key length of a direct file only.

3,id,chars,lines,col,row,border[,heading]

3 specifies a text field (window).

id is a unique single character id from A to Z. When there are multiple text fields in a format, use ascending characters (A, B, C, etc.).

chars is the number of characters per line (width). This is the text size inside the window and excludes the border. Valid values are from 2 to 73.

lines is the number of lines in the window and excludes the border. Valid values are from 1 to 22.

col is the first column position. This is the top left column of text and excludes the border. You must take into account the text width, border, and screen size. Valid values are from 3 to 75.

row is the first row position. This is the top left row of text and excludes the border. You must take into account the number of lines displayed, border, and screen size. Valid values are from 1 to 22.

border is one of the following:

- C Character (- - -) border.
- G Graphic border.
- N No border.
- R Reverse video border.

heading (optional) is the title of the window that displays at the top of the window.

Example:

3,A,60,8,17,11,G,Prospect Phone Log

When you enter this field a window displays that allows 60 characters to be entered. Eight rows display at a time. The window begins on column 17, row 11. The border is graphic. The window title is Prospect Phone Log.

Valid Values: SQL Date Masks

SQL date masks can be used in combination with a 6 byte date type 5 to provide the ability to enter and display both the date and time. Date Type (DT).

The SQL date mask should not be used to maintain time that must be accurate within the second. This date type is only accurate on average within + or - 5 seconds. If you require a more accurate time stamp use the TIM function in Thoroughbred Basic.

IM = "sql-input-mask" DM = "sql-disp-mask"

IM defines a SQL input date mask.

sql-input-mask is any valid SQL date mask.

DM defines a SQL display date mask.

sql-disp-mask is any valid SQL date mask.

For more information on valid SQL date masks, see the DTN and NTD functions in the Thoroughbred Basic Reference Manual.

Example:

IM="MMDDYY HHMI" DM="MM/DD/YY HH:MI"

The input mask MMDDYY HHMI is used to collect the data from the operator. The display mask MM/DD/YY HH:MI is used to display the data. If you type 110697 and 0800 the following displays 11/06/97 8:00.

Default Entry (DE)

Type the default (or preset) value for this Data Name. The value you enter here depends on the Length field. This value displays when performing single and multiple record database maintenance.

You may accept this default by pressing **Enter** or overwrite it and press **Enter**. If however, the Security field defines this Data Name as a system generated field, you may not overwrite the value entered here.

For more information, see Security (SC).

Delete Record (DR)

The Delete Record value specifies the value to be used in testing whether or not a record can be deleted in the delete mode during database maintenance. The value in the Data Name is compared to the delete value and if the relational condition is true, the record can be deleted.

When two or more Data Names specify delete values, the system treats them as a logical AND. All conditions listed in the Data Names must be true.

To prevent any record in the file from being deleted enter = " " in this field.

rel-oper del-val [log-oper rel-oper del-val...]

rel-operator is one of the relational operators (<=,>=,<>, ><)

del-val is the delete value. The delete value must conform to the Data Name definition, including type and padding. An error occurs if an alphanumeric delete value is specified for a numeric Data Name. An error also occurs if it contains non-numeric characters (such as a comma).

log-oper is the logical operator (AND/OR) used to specify more than one relational condition for a delete value.

Example:

=5000

A record can be deleted if the Data Name equals 5000.

<=0

A record can be deleted if the Data Name is less than or equal to 0.

="TEMP"

A record can be deleted if the Data Name equals TEMP.

=350 OR =450

A record can be deleted if the Data Name equals 350 or 450.

>0 AND <100

A record can be deleted if the Data Name is greater than 0 and less than 100 (1 through 99).

Security (SC)

Restricts the use of the add and change modes and the display of data during database maintenance. This specifies a security code and optional password to protect data during maintenance by an operator.

Security code options 1 and 2 are not applicable to scripts.

sec-mode, disp-mode [, password]

sec-mode select one of the following:

- 0 No restrictions (can add and change).
- 1 Restricts changes (can add only).
- 2 Restricts add (can change only).
- 3 Restricts add and change (system generated field).
- 4 Restricts record access to the defined groups. For more information see Security Groups in the OPENworkshop Reference Manual.

disp-mode select one of the following:

- 0 Displays input and output.
- 1 Displays input only.
- 2 Does not allow display of input or output.

password (optional) is a 1 to 3-character password. This password overrides the security mode but not display mode. If you enter a password, it is required in database maintenance regardless of other security settings. An asterisk (*) may be used as the password. This indicates that the password is to be the first 3 characters of the current value of the Data Name.

When the value of the record level security field defined in the format, matches a record level restriction key, only the groups defined for the key are allowed to access the data record.

Examples:

1, 1

Specifies an add only field in which the value is not displayed on the screen when called up.

0, 2

Specifies a field in which the data can be added or changed, but it is not displayed on the screen when entered or called up.

0,0, QRX

Specifies the password QRX must be entered to add or change data. There is no restriction on data display.

0,1,*

Specifies a field in which the data can be added or changed. The user must enter the first 3 characters of the current value of the Data Name before gaining access to the field. The field only displays after you enter the correct password.

4,2,A1

Specifies that record level security is active for this format. Record level security allows the access of data records to be restricted to specified group levels. For more information, see Security Groups in the OPENworkshop Reference Manual.

Message (MS)

Specifies the message to display during database maintenance, when the Data Name is accessed.

Dictionary-based messages

Uses the Dictionary-IV message dictionary. For more information, see Messages in this document.

dictionary;type,num[,disp-mode[,clear[, (col,row)]]]

dictionary is the Dictionary-IV message dictionary name.

type select one of the following message types:
P prompt/constant.
N non-input.
n non-input (print without suffix and no Enter).
x non-input (print without suffix and wait Enter).

num is the number of the message (from 1 to 256) in the dictionary.

disp-mode select one of the following display options:
 (blank) defaults to the Message Definition.
 B is background.
 F is foreground.
 R is reverse video foreground.
 r is reverse video background.

clear select one of the following clear options:
 A clears the line before and after.
 B clears the line before.
 C clears the line after.
 D clears the message area after.
 E clears the screen before and after.
 F clears the screen before.
 G clears the screen after.
 X (or blank) does not clear.

col is ignored by the system.

row is ignored by the system.

The row of the message is controlled by the global format Data Name #IDSV.PROMPT-LINE-NMBR. Specified row and column positions in the messages are no longer honored. For more information, see the Thoroughbred Basic and Script-IV reference manuals.

Example:

OPM1;N,12,R, A

When this Data Name is accessed non-input message number 12 from the OPM1 message dictionary displays. Regardless of the message dictionary definition, it displays in reverse video, and the message area is cleared before and after the message is displayed.

Format-based messages

Creates the message in this Format definition.

[@(col,row[,disp-mode])]msg

@ specifies a format-based message.

col is ignored by the system.

row is ignored by the system.

disp-mode (optional) select one of the following:
 (blank) defaults to the message dictionary definition.
 B is background.
 F is foreground.
 R is reverse video foreground.
 r is reverse video background.
 The default is **R**.

msg is the message text. You can use from 1 to 132 characters for the message. The message may be displayed on two lines (depending on the length and location).

The row and column of the message is controlled by the global format Data Name #IDSV.PROMPT-MSG-NMBR. Specified row and column positions in the messages are no longer honored. For more information, see the Thoroughbred Basic and Script-IV reference manuals.

Example:

@(1,18,R)Do not enter zero!

This specifies the message **Do not enter zero** to be displayed in reverse video background at #IDSV.PROMPT-LINE-NMBR.

Help Prompt messages

Allows the specified help module to be displayed on the screen as a prompt during field entry.

When a help prompt is defined for a field, it is activated by pressing **F6** on that field. The help window displays. It is left on the screen and the cursor returns to the data field. If **F6** is pressed again, the prompt window is removed and the standard help request is processed.

When the field entry is complete, the help prompt window is removed.

If the specified help module does not exist and the operator is defined as a developer, a prompt displays allowing the operator to press **F1** to create the help. Also from the Format Editor pressing **Enter** on the message field allows you to edit the defined special prompt help.

F1 can be used to create a new help prompt when Help Edit Developer/User is set to Developer in Operator Information. For more information, see Set Developer/User in the Dictionary-IV Administrator Guide.

[**HELP**;**help-name**]

HELP is the keyword.

help-name is the definition name of the help text to be displayed.

Example:

HELP; CUSTH

When you press **F6** at this field, help module CUSTH displays and the system returns for input. Press **F6** again to display the normal help for the element.

View Prompt definition messages

This option displays the specified prompt message as the cursor moves from column to column in a CONNECT VIEW. Other types of prompt messages can be specified in addition to the VP [msg]. They will be displayed when the entry mode is invoked on a data field from within a CONNECT VIEW.

When in screen entry with VP[msg] as the only prompt specified, it is the only prompt displayed.

When in screen entry with other types of prompt messages specified (in addition to a VP [msg]), only the other type prompt messages display.

VP[prompt msg]msg-dict;msg-type,msg-num

msg-dict is the Dictionary-IV message dictionary name.
msg-type is the message type.
msg-num is the message number on the message dictionary.

Example:

VP[Press **F2** to execute report]IDMSGSP, 10

In a CONNECT VIEW, the message **Press F2 to execute report** displays when the cursor enters this column. When the input mode is invoked for this field, the prompt message number 10 from the IDMSGSP dictionary displays.

Pre-processing (BP)

Pre-processing allows you to specify a program or script to be executed before data is input to this Data Name.

The Script-IV INPUT SCREEN command ignores any type 0 or pre-processing defined in formats. Any pre-processing for a script must be defined in the script. For more information, see the Script-IV Language Reference.

exec-ind,program[,pass-val]

exec-ind is the Thoroughbred Basic execution indicator. Select one of the following:
0 to CALL the Thoroughbred Basic program, Type 4, or Script Type P.
1 to RUN the Thoroughbred Basic program.
CONNECT to connect to a Class.
program is the program or script name (1 to 8 characters in length). If a program cannot be found, the procedure is ignored.
pass-val (optional) is the string value that is passed to the procedure program in the variable S8\$. This value may be used in the program as a flag or code, to specify a subroutine within the program, for cases where the same program is used to accomplish more than one procedure.

To write a pre-processing program, you may create either a type P script, a type 4 script, or a Thoroughbred Basic program.

- A type P script is recommended. The information passed to the script is documented in the API services in the on-line help under 8INPUT.
- A type 4 script is compatible with older file maintenance pre-processing programs. The information passed to the script is documented in the on-line help under Script-IV Types.

- For a Thoroughbred Basic program, 3GL developers should refer to the help for type P scripts (above) when creating the ENTER statement.

Example:

0,SPCED1, A

The program SPCED1 is executed using CALL, and the value A is passed to the program.

Pre-processing-CONNECT

For more information, see the appropriate CONNECT topic in the Dictionary-IV User Guide.

The following CONNECTs can be invoked before or after field entry:

- CONNECT HELP displays help text.
- CONNECT MENU processes a window menu
- CONNECT QUERY prints a query.
- CONNECT REPORT prints a report.
- CONNECT SCREEN performs screen maintenance.
- CONNECT VIEW performs view maintenance.

CONNECT[(function-key)] Class Class-name [;CONNECT...]

CONNECT is the keyword.

function-key (optional) is the function key to be used to invoke the pre-processing.

Class is the type of CONNECT. Select one of the following:

VIEW
SCREEN
MENU
HELP
REPORT
QUERY

Class-name is the name of the CONNECT Class.

Example:

CONNECT (1) VIEW UTSLS

This specifies when this Data Name is accessed you may CONNECT to the view UTSLS by pressing F1.

Script-IV has its own set of CONNECT commands. For more information, see the Script-IV Language Reference.

Pre-Processing-CONNECT SCREEN/VIEW details

```
CONNECT VIEW view-name
      USING expr RANGE FROM TO expr ]
      SORT [BY] sort-number;
      [SELECT WHEN cond;]
```

```
CONNECT SCREEN screen-name
      [USING expr|RANGE FROM TO expr]
      [SORT [BY] sort-number;][AUTO-EXIT]
```

expr is any valid string or Data Name expression.

Pre-Processing-CONNECT REPORT/QUERY details

```
CONNECT REPORT report-name [,from report name
                             [,to report name
                             [,mask form name
                             [,sort-number
                             [,report output device
                             [,report output type
                             [,report output mode
                             [,program to execute
                             before printing line
                             ]]]]]]]]
```

CONNECT QUERY syntax options are the same as the REPORT options.

Examples:

```
CONNECT SCREEN UTCUST
Invokes the screen UTCUST and allows single-record maintenance.
```

```
CONNECT (3) MENU UTMENU
Invokes the menu UTMENU when F3 is pressed.
```

```
CONNECT REPORT UTXRAR01,,,2, P8
Prints the report UTXRAR01. Uses SORT 2 from the link. The device is the printer P8.
```

Post-processing (AP)

Post-processing allows you to specify a program or script to be executed after data is input to this Data Name.

The Script-IV INPUT SCREEN command ignores any post-processing defined in formats. Any post-processing for a script must be defined in the script. For more information, see the Script-IV Language Reference.

```
exec-ind, program[,pass-val]
```

exec-ind	is the Thoroughbred Basic execution indicator. Select one of following: 0 to CALL the Thoroughbred Basic program, Script Type 4, or Script Type P. 1 to RUN the Thoroughbred Basic program.
program	is the program or script name (1 to 8 characters in length). If a program cannot be loaded, the procedure is ignored.
pass-val	(optional) is the string value that is passed to the procedure program in the variable S8\$. This value may be used in the program as a flag or code, to specify a subroutine within the program, for cases where the same program is used to accomplish more than one procedure.

To write a post-processing program, you may either create a type P script, a type 4 script, or a Thoroughbred Basic program.

- A type P script is recommended. The information passed to the script is documented in the API services in the on-line help under 8INPUT.
- A type 4 script is compatible with older file maintenance post-processing programs. The information passed to the script is documented in the on-line help under Script-IV Types.
- For a Thoroughbred Basic program, 3GL developers should refer to the help for type P scripts (above) when creating the ENTER statement.

Example:

0,SPCED1, A

The program SPCED1 is executed using CALL, and the value A is passed to the program.

Audit (AU)

Specifies whether or not the system automatically keeps track of the file maintenance performed on this field. An additional audit control is supplied in the Link. Audit file reports can be obtained from the Dictionary-IV Utilities. For more information, see Audit File Information in the Dictionary-IV Administrator Guide.

audit-ind[,file-name]

audit-ind	specifies the type of audit. Select one of the following:
1	to audit changes.
2	to audit adds.
3	to audit changes and adds.
4	to audit deletes.
5	to audit changes and deletes.
6	to audit adds and deletes.
7	to audit changes, adds, and deletes.

file-name (optional) is the 1 to 14-character audit file name. It is an index file with a record size of 32. The default audit file is **IDAUDT**.

To enable the specified audits, the Audit field must be set to **Y** in the Link definition for the format. For more information, see Links.

The Audit Indicator switch in Link definition allows you to disable or enable all audits for a file, regardless of format audit indicators.

The more audit files specified for the format, the slower the processing.

Reports on the audit files can be obtained using the Dictionary-IV Audit File Information utility. For more information, see Audit File Information in the Dictionary-IV Administrator Guide.

The audit feature is not applicable to scripts.

Examples:

1, ARAUDT

This specifies an audit of all changes that will be written to the file ARAUDT.

4

This specifies an audit of all deletes that will be written to the default audit file IDAUDT.

SCREENS

Screens display and collect data. Once you create your format and create your data file, you may begin using a system generated default screen for database maintenance.

If you are operating in a Multi-Language environment see Multi-Language in the Dictionary-IV Administrator Guide.

Screen definition allows you to design custom display screens, menus, and input screens. You may create them as a window or a non-window.

All future enhancements and development will use Window Objects. We recommend that you create all new screens as window screens. VIP 4.01 requires window screens. The Dictionary-IV Supplemental Utilities menu provides Window Conversion Utilities. For more information, see the Dictionary-IV Administrator Guide.

Display Screens

Display screens do not handle data and do not need a Format definition. Use the screen editor to type the information that will display.

Menus

Menus require a format with one Data Name to define the field. You may use the Dictionary-IV IDMENUIN format or create your own. Use the screen editor to type the information that will display on the menu (including the selection field). Use the Menu definition to describe the action to take place with the option selection.

Input Screens

Input screens are used by single-record database maintenance, Script INPUT SCREEN, Script PRINT SCREEN, CONNECT SCREEN, and the API 8INPUT. They require a format. For more information, see Formats. Also see Database Maintenance in the Dictionary-IV User Guide.

Types of Screens

Default Screen

Thoroughbred Dictionary-IV automatically generates a default screen from the format if a custom screen does not exist. The default screen contains all Data Names defined in the format, is very basic in design, and cannot be altered.

Custom Screens

You may want to use a screen that has fewer fields to maintain, or is organized or displayed differently. Dictionary-IV provides the ability to create your own custom screens.

In the screen header you may define the position and size of the screen.

In the Screen Editor you may enter text, data fields, special code characters, and display-mode characters. You may also preview your design as you create your Screen definition.

Selection

Select **1-Edit** from the Dictionary-IV Development Menu or press **F1** from any Dictionary-IV menu. The system displays the Class pop-up menu:



Select **2-Screens**.

A screenshot of a 'Screen View' window. The window title is '<F1>Edit <F2>Screen File Maint <F3>Print (Change name)-Copy or Rename'. The window contains a table with the following columns: Screen Name, Link/Fmt Name, Description, W, After, Screen, Hdr, GUI, and Scrn. The 'W' column has sub-columns 'F' and 'Read'. The 'Screen' column has sub-columns 'Mth' and 'Help'. The 'Hdr' column has sub-columns 'Typ' and 'Type'. The 'GUI' column has sub-columns 'Typ' and 'Type'. The 'Scrn' column has sub-columns 'Typ' and 'Type'. The table contains 13 rows of data, with the first row highlighted in green.

Screen Name	Link/Fmt Name	Description	W	After	Screen	Hdr	GUI	Scrn
			F	Read	Mth	Help	Typ	Type
UTCUST	UTCUST	Sample Customer File	Y					3
UTFORMAT	UTFORMAT	Convert Report to REPORT-IV	N					
UTINV	UTINV	Sample Invoice Collection	Y					3
UTLOGIN	UTLOGIN	LOG-IN SCREEN	Y					3
UTMENU10	IDMENUIN	IDOL IV - Control Menu	Y					3
UTMENU11	IDMENUIN	IDOL IV - Supplemental Util	Y					3
UTMENU12	IDMENUIN	IDOL IV - Upgrade Menu	Y					3
UTMENU13	IDMENUIN	IDOL IV - Multi-language Ut	Y					3
UTMENU20	IDMENUIN	IDOL-IV Control Menu	Y					3
UTMENU21	IDMENUIN	IDOL-IV Development Menu	Y					3
UTMENU22	IDMENUIN	IDOL-IV Multi-Language Util	Y					3

Components of Screen View

The Screen definition is composed of two parts: the screen header information and the Screen Editor.

Screen View Header Information

The screen header information consists of the name, description, link/format name, screen size and position, help size and position, and the header title location. It also displays the date and time that the screen was last changed and the language code.

Screen Name

Type from 3 to 8 alphanumeric characters for the name of this screen. This field is mandatory.

Characters one and two are the Library name. Characters three through eight are the screen name.

For more information, see Class definition in this document, which provides a file naming convention you may implement.

Link/Format Name

Specifies a 2-character library name followed by a 1 to 6-character link name.

This associates the screen to the link or the format and data files. You can then use this screen for CONNECT SCREEN, Script-IV, and 8INPUT.

Press **F2** to lookup the available Link definitions.

If you do not intend to use the screen for data entry or menu selection, a format is not necessary.

The default is the name of the Screen definition.

Description

Type up to 40 alphanumeric characters for the description of this screen. This field is optional.

Screen Window Flag (WF)

Displays a Y if this is a windowed screen. Displays an N if this is a non-windowed screen. All Object-oriented screens are windowed by default.

After Read Method

You may use this field only if you have installed OPENworkshop. It contains the name of a developer-supplied method that will be called after each record is read and before it is displayed. Refer to OE.OEACUST as a guide to developing After Read Methods. Type the 8-character name or press **F1** (or **F2**) to select and edit the method. For more information, see the OPENworkshop Reference Manual.

Screen Help

Defines the name of the help displayed for the Screen.

Header Type

This field controls the use of the screen description in the window's top border. It is only available if you have defined this screen as a window.

For non-windows you can define the header title in the Screen Editor. For more information, see "Using the Screen Editor" in this document.

Select one of the following:

- blank** Screen description does not appear in the window title area.
- C** Screen description is centered in the top border of the screen's window.
- R** Screen description is right justified in the top border of the screen's window.
- L** Screen description is left justified in the top border of the screen's window.

The default is **blank**. If this is a non-window, the system positions the cursor at the Screen Editor.

GUI Scrn Type

If running a character application, this field can be ignored. If running VIP, select one of the following:

- 3** Defines the GUI Screen Type as a graphical screen.
- 4** Defines the GUI Screen Type as a graphical template.

Last Change Date

Displays the date of the last change to the selected Screen.

Create Date

Displays the date of creation of the selected Screen.

Screen Editor

Press **F1** in the Screen Name field to select the Screen Editor.

If this is a windowed screen the system displays the Screen for editing. Below is an example:

```
DEFINITION LISTING

Library.....: _

List all Definitions? _ (Y/N)

from definition....: _____ (RETURN for first)
to definition.....: _____ (RETURN for same or last)
using name mask....: _____ (RETURN for none)
```

If this is a non-windowed screen the system prompts:

```
The requested screen definition must first be converted to window type screen.
<CR> to convert or <F4> to exit.
```

When you press **Enter** the system opens the Screen Editor. If, however there is a size conflict, the system prompts:

```
Screen size and window size conflict:
Name: hGCLSEL Size chars: 80 lines: 24 Home col: 00 line: 00

The screen size and home location can not be converted into a window of a
the same size at the same location. If converted, the window will be
saved as it is currently displayed. Use <CR> or <F4> to continue. You
will have the option to convert this screen. Use <F2> to move this window
in order to preview the entire screen.
```

When you press **Enter** or **F4** the system prompts:

Convert?

Select one of the following:

Y Converts to a windowed screen.

N Exits the screen editor.

You may now edit the Screen.

Using the Screen Editor

From the Screen Editor you can add text, add special code characters, and fields.

Quick Key Reference (Screen Editor)

Key	Description
F1	Preview. Shows how the screen will appear when displayed in database maintenance or an application. Press F4 or Enter to return to Screen definition.
F5	Defines a Data Name in the window. Place the cursor where the field is to be located and press F5 . A data field entry window displays. Enter a valid Data Name or expression. For more information, see the Creating Data Fields.
F7	Displays Special Functions. For more information, see F7 Special Functions.
F10	Displays a view of the Data Names or the language data descriptions from the Format definition. Press Enter to select Data Names.
F15	Selects display attributes, colors, and toggles character and graphic mode.

Special Code Characters

Special codes are provided to display information that might change each time the screen is accessed. The special code characters that can be used are:

/D	System Date (DAY)
/d	Terminal Date
/f	File Suffix Value
/I	Installation Name
/i	Terminal ID
/L	Language Code
/n	Name of Window
/o	Operator Code
/T	Time (12-hour, no seconds)
/t	Time (TIM)

All special code characters must be preceded by a space.

When using the special code characters you must consider the length of the resulting value and position the code on the screen accordingly. For example, **/D** results in an 8-character date when the screen displays.

Press **F1** to preview the screen as it will appear during database maintenance. The special codes are replaced with the corresponding current values.

F7 Special Functions

Select **F7 Special Functions**.

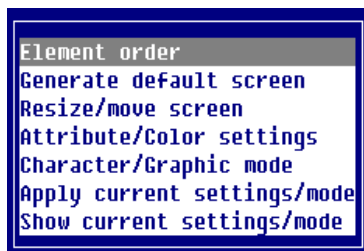

Element order

Use this function to control the order in which Data Names are collected during data entry.

Key Data Names must be the first elements and must be sequential.

Select **Element order**. The system prompts with a listing of the Data Names:

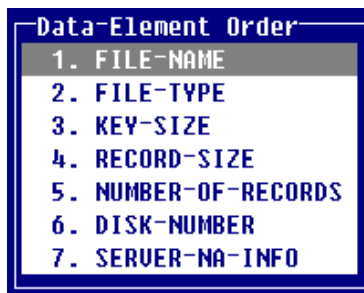

The system lists each Data Name from the corresponding format. Select the Data Name to be moved and the system prompts:

Move data-element number x to: __

Type the number of the position where you want the Data Name to move. Press **Enter**. The data field moves to the new location in the list and the items reorder.

The Data Name order does not change on the screen, only the collection order changes during screen maintenance. For example, if you move the Rep-Code in UTCUST from its current position (8) to a new position (3), the positions do not change on the screen. When you perform screen maintenance you will enter the Customer-Code, Customer-Name, Rep-Code, Address, and then continue in the defined order.

Generate default screen

Allows you to display the system-generated screen. Select **Generate Default Screen**.

The system prompts:

Do you want to generate default screen?

Select **Y** to generate the default screen (system generated screen) in the Screen Editor area. You may edit it to produce a custom screen.

Prior to creating the default screen, use the Resize/Move option to create an appropriate screen size.

Resize/move screen

Allows you to resize and move the screen.

Select **Resize/move screen**. The system displays the resize box in the lower right corner. Press **F1** to toggle between resizing and moving the window.

Resize

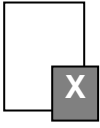
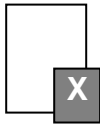
Mode	 Bottom row and right column move to expand and reduce the window size.	 Top row and left column move to expand and reduce the window size.
Key		
Left Arrow Right Arrow Back Tab Tab Up Arrow Down Arrow Page Up Page Down	decreases width 1 increases width 1 decreases width 5 increases width 5 increases height 1 decreases height 1 decreases height 5 increases height 5 rows	increases width 1 decreases width 1 increases width 5 decreases width 5 increases height 1 decreases height 1 increases height 5 decreases height 5 rows
Enter Home . (Period) F1 F4 F7	toggle window resize modes. expand to maximum number of rows. expand to maximum number of columns. toggle window resize and window move. terminate window resize and window move. special functions menu.	

Press **F7** to select the following options:

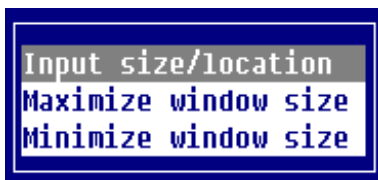

Input size/location

Allows the size of a text window to be changed. The window text size values will be displayed in the edit mode window.

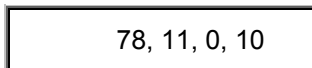

Window Size: 78 columns, 11 rows.

Coordinates: column 0, row 10.

Maximize window size

Expands the window size to the maximum size allowed. The window location will not be changed. The window will be expanded from the top down and from right to left.

Minimize window size

Reduces the window size to the minimum size allowed. The window will be reduced from the bottom up and from right to left.

Move

Key	Action
Left Arrow	moves to the left 1 column.
Right Arrow	moves to the right 1 column.
Back tab	moves to the left 5 columns.
Tab	moves to the right 5 columns.
Up Arrow	moves up 1 row.
Down Arrow	moves down 1 row.
Page Up	moves up 5 rows.
Page Down	moves down 5 rows.
Enter	toggle window resize modes.
Home	expand to maximum number of rows.
. (Period)	expand to maximum number of rows.
F1	toggle window resize and window move.
F4	terminate window resize and window move.

Attribute/Color settings

The display attributes, color settings, and character and graphic modes can be controlled from here or by pressing **F15**. For more information, see **F15 Character/Graphics Mode - Video Attributes, Graphics, and Color**.

Character/Graphic mode

This option toggles between character and graphic mode.

Apply current settings/mode

This option applies the current display attribute/color settings and character/graphic mode based on the current cursor position. The settings display in the edit mode window at the bottom of the screen.

Show current settings/mode

This option displays the current display attribute/color settings and character/graphic mode based on the current cursor position. The settings display in the edit mode window at the bottom right corner of the screen.

F15 Character/Graphics Mode Video Attributes, Graphics, and Color

Specifies the text and background attributes to be used in the window and, if you are using a properly configured color terminal, the use foreground and background color.

If you are operating on a black and white terminal:

- You can only select the window attributes (any combination of reverse video, underscore, background, and blink).

If you are operating on a color terminal:

- You can select the window attributes (any combination of reverse video, underscore, background, and blink).
- You can select colors for the text foreground and background on your custom screen. You may select from up to 16 colors.
- You can only select colors if the Save Color Maps has been enabled in Installation Information. For more information, see the Utilities Reference in the Dictionary-IV Administrator Guide.

The window attributes and colors should be set before entering text or codes. To change them for text already entered, you must select window attribute and/or color then type over the existing text.

Press **F15**.



You may toggle Reverse Video, Background, Underline, and Blink. For more information on using the color pallet, see Using Attributes/Color Settings. Once you make your selections you select **<Execute>**.

A status bar appears at the bottom of the screen that displays the currently selected attributes.

Window Attributes

The window attributes available are:

None



Full intensity characters.

Reverse Video



Full intensity background (area around characters).

Background



Half intensity (can be characters or background).

Blink



Blinking area of screen.

Underline



Underscored area of screen.

These attributes may be used in any combination providing 16 different combinations.

It is important to remember that all terminals do not support underscore and blink.



Foreground



Background

Set your default window attributes in the Window Configurator. For more information, see Window Configurator in the Dictionary-IV Administrator Guide.

Foreground/Background Color

There are 16 colors available for the Foreground and Background.

These colors will display only if the option for Display Default Colors in the Operator Code screen is set to **N**. If this option is not specified or is set to **Y**, the default colors from the color selector will be used when the window is displayed. For more information, see Operator Code Information, Operator Information, and Window Configurator in the Dictionary-IV Administrator Guide.

You can only select colors if Save Color Maps has been enabled in the Installation Information. For more information see Installation Information in the Dictionary-IV Administrator Guide.

When you make your selections, the system displays a sample at the bottom of the window.

Using Attributes/Color Setting

Keys available in this option are:

- Left Arrow** Moves the lightbar left across the Foreground/Background color.
- Right Arrow** Moves the lightbar right across the Foreground/Background color.
- Up Arrow** Moves the lightbar up from Foreground to Background attributes.
- Down Arrow** Moves the lightbar down from Foreground to Background attributes.
- F4** Exits returns to the pop-up menu.
- F6** Displays on-line help.
- F7** Restores the original attribute/color settings.

Place the cursor where the window attribute or color is to begin. Select the Attribute/Color Settings option. The system displays one of following:

Color Terminal

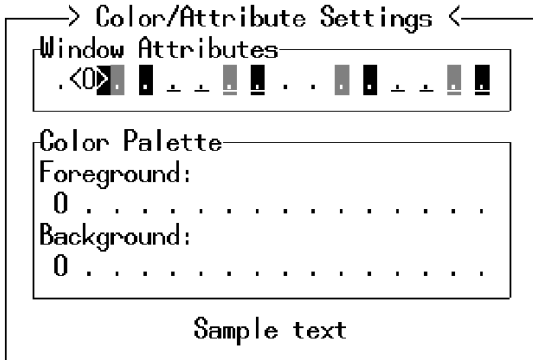

Black and White Terminal

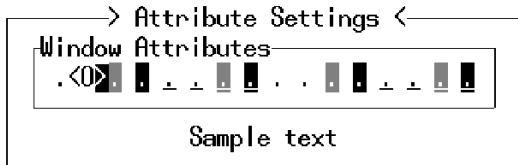

The <0> indicates the current setting. Use the appropriate arrow keys to make your selection. Your selections appear at the bottom of the window as Sample text.

Press **F4** to exit then select <Execute> to save your selection. Type the text or press **F5** to insert an entry field. The system displays the text or entry field in the attribute/color selection you have chosen.

You may continue using this selection or make another selection. When you exit and save the screen modifications, the system saves the attributes/color selections you made. If you create another screen, the system returns to your default colors.

These default colors are defined in the Window Configurator. For more information, see Window Configurator in the Dictionary-IV Administrator Guide.

The color attributes cannot be changed if the ability to save the color attributes has been disabled. Once this feature has been disabled, color attributes will be lost when the window is saved. If color text is saved on a non-color terminal, color attributes will be lost when the window is saved.

Character/Graphic Mode

Select this to toggle between character and graphic mode.

In the character mode, the numbers operate normally. In the graphic mode they create graphic lines.

The following shows the numeric keypad in the character mode (left) and in the graphic mode (right):

Character/Graphic Mode

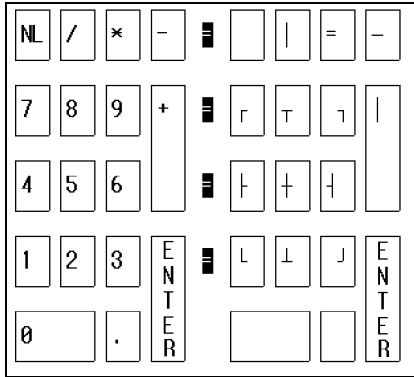

The cursor keys and edit keys still function as in character mode. All other keys are invalid and a "ring bell" will occur if they are used.

Cursor movement will be clockwise after graphic corners are entered and will go in the direction of an intersect graphic character. A graphic center intersect will use the last direction mode.

Creating Data Fields

Data Name fields are the fields where data will be input during file maintenance or in a script. The names and attributes of these fields are defined in the format for the screen.

Multiple occurrence Data Names can be used as well as single elements. A data field is created by entering the Data Name in the data field window. The screen displays underscore characters on the screen equal to the field length.

Display Data Names

From a window screen this option allows you to create fields descriptions for these fields. The descriptions are based on criteria you set by pressing **F7** from this option.

Press **F10** and the system displays the Data Names. Press **F7** and the system displays the following:

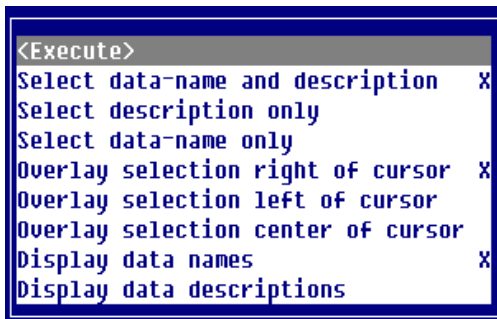

Use this option to:

- Select what is placed in the editor when an item is selected from the Data Name view (Data Name only, Data Description only, or both the Data Name and description.).
- Place the selected item.
- Determine whether the Data Name view contains Data Names or Data Descriptions.

Select one of the following:

<Execute>

Exits and applies the changes.

Select data-name and description

Returns formula and description.

Select description only

Returns description text only.

Select data-name only

Returns formula only.

Overlay selection right of cursor

Puts the selection to the right of the cursor.

Overlay selection left of cursor

Puts the selection to the left of the cursor.

Overlay selection center or cursor

Centers the selection on the cursor.

Display data names

Displays data-names in the view.

Display data descriptions

Displays data descriptions in the view.

Select one of the Data Names or descriptions and press **Enter**. The system places the name/description (based on the criteria you set) and a place for the data entry (based on the attribute settings in Format definition).

Defining Data Fields

To define a formula or qualify input of a Data Name (masking, size of input field, multiple occurrences) in a screen, place the cursor where the field will be located and press **F5**. A definition window opens and you can type in a valid Data Name or expression.

Once in the definition window, you can use **F10** to display a view of Data Names in the format. The standard view movement keys can be used to scroll through the names (for example, **Up Arrow** and **Down Arrow** keys), and press **Enter** to select a name and bring it into definition window, or press **F4** to exit.

If an expression is used, the value is only for display and cannot be changed in maintenance. This is referred to as a formula. For information, see Computed Data Field Syntax (Formulas) in this document.

Select the Data Name and Press **F5** to Save.

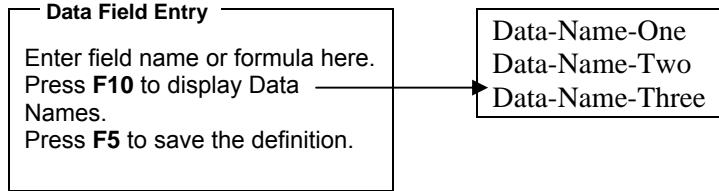

Editing the Data Field Window

The following functions are available in the data field window:

Split the Line

Press **F1** to split the line where the cursor is located. The text from the cursor position to the right will be relocated to a newly inserted line.

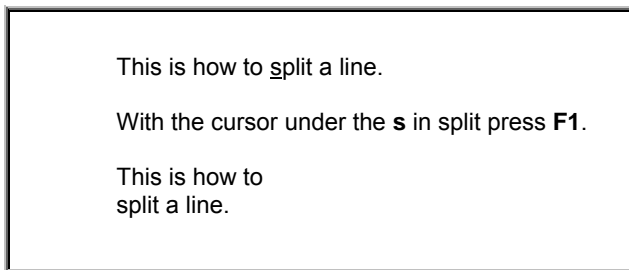

Join the Line

Press **F2** to join the following line to the end of the cursor line.

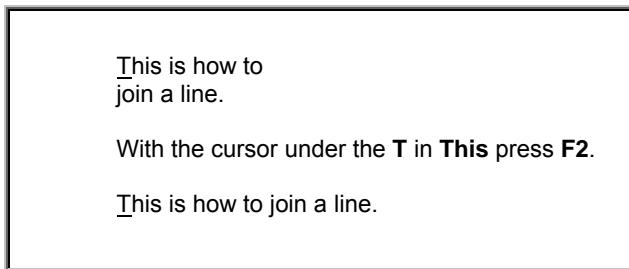

Exit without Saving

Press **F4** to exit the data field definition window without saving.

Save and Exit

Press **F5** to save and exit the definition or press **F4** to exit without saving. If you have entered a nonexistent Data Name or incorrect syntax, pressing **F5** to save the data field will result in an error message.

If you get an error message, check the following:

- Data Name spelling including hyphens and capitalization.
- The spelling and format of a `/FIELD(width)=` command. For more information, see Input Window for a Data Field in this document.
- Masking formats.
- Calculation syntax and logic.

On-line Help

Press **F6** to display on-line help.

Expand the window

Press **F9** to expand the window.

Display the Data Name List

Press **F10** to display a view of element names in the format. Use the standard view selection keys to scroll through and select an element name.

- **Up Arrow, Down Arrow, Home, Page Up, and Page Down** scrolls the view.
- **Enter** selects the Data Name, exits the list, and brings the name into the window.
- **F4** exits the Data Name list and returns to the data field definition window.

Input Window for a Data Field

An input window can be created for a data field by preceding the Data Name with:

`/FIELD(len)=`

len is the length of the window, which is shorter than or equal to the element length. The field will scroll horizontally to accept the maximum length entry defined for the Data Name in the format.

Computed Data Field Syntax (Formulas)

The following procedures are the same for both windows and non-windows (except where noted).

A computed data field is created by using any of the Data Names from the format in an expression. 3GL functions and variables can be used as well as single and multiple occurrence Data Names.

Computed data fields make use of formulas.

The value in the computed field is created using the current values for any Data Name and 3GL variable. The operator cannot change the resulting contents of the field.

A computed data field is for display only.

A Data Name field can be changed into a computed field simply by specifying the addition of a space or zero to it, depending upon whether the element is string or numeric. This excludes the displayed value from change by the operator, regardless of the settings for security in format.

When using multiple occurrence Data Names in a computed field you must specify which occurrence to use. For example, COST(3) is valid, COST is not.

A display window can be created for a formula by preceding the Data Name with:

/FIELD(width)=

Width is the length of the window. This must be shorter than or equal to the element length.

String Formula

Use the following syntax to set up string formulas:

```
[ /FIELD(len)= ] str-elmt [ ( strt, len ) ] |  
      rep-str-elmt ( num ) + str-val . . .
```

/FIELD is the keyword.

len is the window size.

str-elmt is the name of a string Data Name defined in format.

strt,len (optional) is a substring of the Data Name value. Strt indicates the position to begin the substring and len is the number of characters of the substring.

rep-str-elmt is a repeating field name (multiple occurrences).

Examples:

The following examples are based on a format with alphanumeric Data Names LAST-NAME with length=20 and FIRST-NAME with length=10, and alphanumeric multiple occurrence element MONTH with length=12 *4.

```
/FIELD(6)=LAST-NAME(1,4) + FIRST-NAME
```

This specifies a computed data field, based on the current values of the Data Names. The resulting value is the first four characters of the value in LAST-NAME plus the value of FIRST-NAME. Only six characters of the entire value are displayed on the screen. This field cannot be modified in file maintenance or scripts.

LAST-NAME + " "

This specifies a display-only field which is the value of LAST-NAME with a space appended. The user cannot modify this data field.

MONTH(1) + MONTH(12)

The values of occurrence 1 and occurrence 12 of the Data Name MONTH are concatenated together. The user cannot modify this data field.

Numeric Formula

Use the following syntax to set up numeric formulas:

```
[ /FIELD(len)=] num-elmt | rep-num-elmt(num) num-oper num-val... [ : "mask" ]
```

/FIELD is the keyword.

len is the window size.

num-elmt is the name of a numeric Data Name defined in the format.

rep-num-elmt is a repeating field name (multiple occurrences).

num-oper is a valid arithmetic operator (+ - * / ^).

num-val (optional) is a numeric constant.

"mask" (optional) is a mask used for numeric formatting. Only one mask (positioned at the end of the formula) is used per formula. For more information, see Mask Characters in the Dictionary-IV User Guide.

Examples:

These examples are based on a format with numeric Data Name COST, length=8.2, and numeric multiple occurrence element VALUE, with length = 8.2 * 5.

COST * VALUE(4)

The product of the current value of COST and the fourth occurrence of VALUE is displayed in this field and cannot be modified by the operator.

/ 4: "\$###,###.00"

If the value of COST is 8.4, then the value of this field (8.4/2) will be calculated and formatted for display as \$2.10. The user cannot modify this field.

VALUE(1) + VALUE(2) + VALUE(3) + VALUE(4) + VALUE(5)

The values of all occurrences of VALUE are added together and displayed in this field. The user cannot change the resulting value.

Conditional Formula

This formula displays the calculated value if the condition is true.

IF cond THEN /FIELD(len) = val

cond is an expression or statement, which is tested to determine whether or not the formula will be calculated.

len is the number of characters used to display the calculated value.

val is a Data Name or formula (as described previously) that results in a value.

Examples:

Assume that you want to calculate Gross Profit for an accounting screen. You could define a formula for Gross Profit as follows:

YTD-SALES - YTD-COST

However, if you want to calculate Gross Profit Percent, you need to divide Gross Profit by the YTD-SALES:

$(\text{YTD-SALES} - \text{YTD-COST}) / \text{YTD-SALES}$

This would cause an error whenever YTD-SALES had a value of zero, because division by zero is an undefined mathematical statement.

To avoid this error, you can use a conditional formula as follows:

**IF YTD-SALES <> 0
THEN /FIELD(8) = (YTD-SALES-YTD-COST)/YTD-SALES**

Assignments in a Formula

This is useful for creating a calculated default value, this formula displays value-1 and assigns value-2 to the specified Data Name.

val-1; data-name = val-2

val is a Data Name or formula (as described previously) that results in a value.

Conditional Assignments in a Formula

This formula displays value-1 in the formula field, and if the condition is true, assigns value-2 to the specified Data Name.

val-1; IF cond THEN data-name = val-2

val is a Data Name or formula (as described previously) that results in a value.

cond is an expression or statement, which is tested to determine whether or not the assignment will be performed.

This type of formula is a combination of a conditional formula and using an assignment in a formula.

Calculated Default Values in a Formula

It is sometimes useful to assign the result of a formula calculation to another field. For example, using a formula, you can assign a default value to a field based on a calculation of values in other fields. This, in effect, creates a calculated field for which the operator can change the value of the result.

Calculated Fields in a Formula

You can use a calculated field in a formula, but the fields used in the calculation must be defined in the format (although it does not have to be in the data file).

Example

$\text{HOURS} * \text{RATE} = \text{GROSS-PAY}$

If the GROSS-PAY field is in the format, you can assign the result of the calculation to the GROSS-PAY field.

$\text{GROSS-PAY} * .0127 = \text{STATE-TAX}$

You can then use the calculated GROSS-PAY field, in a formula, calculate State Tax.

Calculated Values Stored in the Data File

The result of a formula calculation is not stored in the data file. However, you can define a formula so that it will automatically store the calculated value in the data file.

This may be an uncommon operation, but it is presented here to illustrate additional features in the screen formula. To do this, you must:

- Define in the format a Data Name that will store the calculated value.
- Define in the screen a special formula where you assign the calculated value to the Data Name.

Example:

Define the following format:

NAME (length = 10)

RATE (length = 5.2)

HOURS (length = 2.0)

GROSS-PAY (length = 6.2)

Define a screen containing all the Data Names. Then, in between RATE and HOURS, add the following formula field called OVERTIME-RATE:

RATE + (RATE / 2); GROSS-PAY = HOURS * RATE

This formula will display the Overtime Rate of time-and-a-half and then assign the Gross Pay calculation to the GROSS-PAY field. When the record is added or changed, the calculation will be stored in the data file under GROSS-PAY.

Additional Formula Examples

The following fields are taken from a customer inquiry screen and show examples of formulas with assignments:

CUST-SALES-YTD:"###,###.00"

Displays the year-to-date sales for customers using the defined mask.

CUST-COST-YTD:"###,###.00"; GROSS-PROFIT =
CUST-SALES-YTD - CUST-COST-YTD

Displays the year-to-date cost for customers using the defined mask. Calculates a Gross Profit field by subtracting year-to-date customer cost from year-to-date customer sales.

GROSS-PROFIT:"###,###.00"; GROSS-MARGIN =
(GROSS-PROFIT * 100) / (CUST-SALES-YTD + .01)

Displays the Gross Profit field using the defined mask. Calculates the Gross Margin by multiplying the gross profit by 100 and dividing it by the year-to-date customer sales (plus 1%).

VIEWS

A View displays multiple records at one time and allows database maintenance. It displays each record on a separate line. Since in Format definition you may specify up to 255 data names (fields), you may find data written past the edge of the window.

You can use the **Up Arrow**, **Down Arrow**, **Left Arrow**, and **Right Arrow** keys to scroll through the data.

You may create multiple views for one file. If you have a lengthy customer file containing a customer code, name, address, contact, telephone, sales y-t-d, and notes, you can create a telephone listing view from this file.

If you are operating in a Multi-Language environment, see Multi-Language in the Dictionary-IV Administrator Guide.

Types of Views

After creating a Format, Link, and data file, like screens, you may create two types of views:

Default

The system generates a default OPENworkshop View when selecting View Database Maintenance (CONNECT VIEW). You may perform Database Maintenance immediately or create a custom view.

Custom

You may create a custom OPENworkshop View from the default view. You can move columns, delete columns, etc. and save the OPENworkshop View with another name. In the View header you define the Link/Format for the view, determine whether data can be edited from the view, and define the help window size. In the View Editor you can manipulate the columns to create the view.

You can maintain Dictionary-IV Views created in previous releases from Views Dictionary-IV.

OPENworkshop Views

Selection

Select **1-Edit** from the Dictionary-IV Development Menu or press **F1** from any Dictionary-IV menu. The system displays the Class pop-up menu.

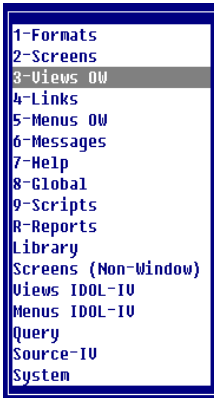

Select **3-Views OW**.

OPENworkshop Views

F1 or F2 - Edit/Display view F3 - Print (Change name)-Allows Copy or Rename

> Object Views <

View Name	Link Name	View Description	K	D	D	U	C	Z	B	C	C	D	C	N	View Method	Help Name
NUMS	8DNUMS	Numeric Types	Y	Y	Y	Y	N		D	F	E	D				
ID8HELP	ID8HELP	IDOL IV - HELP For	Y	Y	Y	Y	N		D	F	E	D	N			
ID8SCUC1	ID8SCLC1	Compile Error File	N	N	Y	N	N	Y	D	F	F	D	D			
ID8SCUC2	ID8SCLC2	Compile IFDEF Defi	Y	Y	Y	N	Y	Y	D	F	E	D	D			
ID8SCUD0	ID8SCLD0	Library File View	Y	Y	Y	N	Y	Y	D	F	E	N	D			
ID8SCUF1	ID8SCLF1	Source Lock Detail	Y	Y	Y	Y	N		D	F	F	N	D			
ID8SCUF2	ID8SCLF2	Source Lock Detail	Y	Y	Y	Y	N		D	F	F	N	D			
ID8SCUF3	ID8SCLF3	Source Lock Detail	Y	Y	Y	Y	N		D	F	E	N	D			
ID8SCUS0	ID8SCLS0	Source File View	Y	Y	Y	Y	Y	Y	D	F	E	D	D			
ID8SCUS1	ID8SCLS3	Currently Locked S	Y	Y	Y	Y	Y	Y	D	F	F	D	D			
ID8SCUS2	ID8SCLS2	Backup Source File	Y	Y	Y	N	Y	Y	D	F	E	D	D	N		

View name

Quick Key Reference

Key	Description
Line Delete	Deletes the selected view. The system prompts: Delete record? Select Y to delete the View; select N to perform maintenance without deleting the View.
Line Insert	Adds a view.
Right Arrow	Moves the lightbar one column to the right. It wraps at the border.
Left Arrow	Moves the lightbar one column to the left. It wraps at the border.
Down Arrow	Moves the lightbar one record down. It scrolls at the border.
Up Arrow	Moves the lightbar one record up. It scrolls at the border.
Tab	Moves the lightbar one column to the right. It scrolls at the border.
Back Tab	Moves the lightbar one column to the left. It scrolls at the border.
Page Down	Moves the lightbar down 1/2 the window length.
Page Up	Moves the lightbar up 1/2 the window length.
Enter	Enters the edit mode in the selected column. Press Enter again to exit the edit mode.

The following function keys are available:

Key	Description
F1/F2	Displays and edits the view. When the system displays the view you may use the arrow, page, home, insert and delete keys as described in CONNECT VIEW in the Dictionary-IV User Guide.
F4	Exits.
F6	Displays on-line help.
F7	Displays the Special Functions menu.
F8	Displays the F8 Commands. Press F10 Goto and F2 Lookup to display all joined column data names. When using the F8 View Commands joined columns are not included when performing the Sum function or the Change function.
F9	Displays the View Specification window. For more information, see Setting View Specifications.
F10	Prompts for the view name to go to.
F12	Displays the Database Maintenance window. You can select Screen Maintenance or View Maintenance from this window.
F16	Prints the view.

Components of OPENworkshop Views

OPENworkshop Views displays all views in all libraries. This view contains all the features of View definition maintenance and view database maintenance. You can also modify the appearance of this view.

For more information about editing the appearance of a view, see View definition. For more information about View Maintenance, see CONNECT VIEW in the Dictionary-IV User Guide.

If you are operating in a Multi-Language environment see Multi-Language in the Dictionary-IV Administrator Guide.

The OPENworkshop View is composed of the header information and a listing of the existing views.

OPENworkshop View Header Information

The header information consists of existing view names, view descriptions, link name, and view specifications as defined in View definition.

View Name

From the View Name column you may perform view maintenance.

For information about performing view maintenance or changing the appearance of a view, see CONNECT VIEW in the Dictionary-IV User Guide.

Link Name

Type from 3 to 8 alphanumeric characters for the link to be used for this view.

View Description

Type up to 40 alphanumeric characters for the view description.

OPENworkshop View Detail Information

Once you have added, copied, or renamed a view, you may change the view specification. You can press **F9** to display and edit the view specifications window.

Key Changes (KC)

Controls the ability to add and delete records and to use **F8** CHANGE, DELETE, COPY, and MOVE commands in a view. Select one of the following:

Y Allows changes to the key fields in the view.

N Does not allow you to change the key fields.

Data Changes (DC)

Controls the ability to add and delete records and to use **F8** CHANGE, DELETE, COPY, and MOVE commands in a view. Select one of the following:

Y Allows changes to the non-key fields in the view.

N Does not allow you to change the non-key fields.

Display Headings (DH)

Turn on or off the view headings. Select one of the following:

- Y** Allows you to display the headings.
- N** Does not display the headings.

View Changes (VC)

Controls the ability to delete or insert columns or to save a view. Select one of the following:

- Y** Allows view specification changes.
- N** Does not allow view specification changes.

Sort Changes (CS)

Turn on or off the ability to use **F5** Sort to select a different sort sequence pattern. Select one of the following:

- Y** Allows view sort changes.
- N** Does not allow view sort changes.

View Zero Print (ZP)

Display/print zeros or blanks for the numeric value zero. Select one of the following:

- Y** Prints zeros (0) when the numeric data is zero (0).
- N** Prints blanks when the numeric data is zero (0).

Border Heading (BH)

Contains view window heading specifications. The headings always display in the top border of the view window. Select one of the following:

- D** The view description is centered in the top border.
- V** The eight-character view name is displayed in the left-most top border.
- B** Both the eight-character view name and description are displayed in the top border.
- N** No headings display in the top border.

CR Mode (CM)

Defines the action of the **Enter** key while in the view. Select one of the following:

- F** Enter the normal field edit mode.
- S** Enter screen maintenance.
- s** Enter screen maintenance and return to View after record is edited.
- E** Exit the view.

Cursor Type (CT)

Defines the view lightbar specifications. Select one of the following:

- C** One character cursor marks the column/row intersection.
- E** Full field lightbar marks the column/row intersection.
- F** The full row is marked with the lightbar.

Display Data Name (DD)

Display the data names in the bottom border of the view flag. Select one of the following:

- N** Do not display the data name or description.
- D** Display the data name.
- d** Display the data name description.

CR Direction (CD)

Defines the direction of the lightbar movement after pressing the **Enter** key to modify a field. Select one of the following:

- U** The lightbar goes up to the prior column row.
- D** The lightbar goes down to the next column row.
- L** The lightbar goes left to the previous column.
- R** The lightbar goes right to the next column.

Numeric Mask (NM)

Defines the default mask for numeric columns in the view.

- N** Use the format mask without commas. For example: one thousand would be displayed as 1000 refer to Thoroughbred Basic syntax: ATR(FMT\$,DN,25)
- C** Use the format mask with commas. For example: one thousand would be displayed as 1,000 refer to Thoroughbred Basic syntax ATR(FMT\$,DN,26).

Each numeric column can also have a display mask defined, which will override the default view numeric mask. Press **F3** on any numeric column to define the column mask.

View Method

You may use this field only if you have installed OPENworkshop. Contains the name of a developer-supplied method that will be called each time a view row is to be displayed. The method will build all new column values that have been defined by new columns (A<x> through Z<x>). Refer to OE.OEVMCUST as a guide for developing view methods to resolve new column definitions. The VIEW METHOD is specific in the view header. For more information, see the OPENworkshop Reference Manual.

Help Name

Contains the name of the help code, which provides overall help for a view. Usually this help should give the user an idea as to the need for a view rather than detail information about individual objects in a view. The help code associated with each data name in the view can be used to accomplish detail help.

Sort Menu Name

Contains the name of a menu to be used in place of the default sort selection pop-up menu. This menu can be more application specific than the default sort selection menu.

Example:

In an employee file you may decide to restrict a salary sort from the current operator. You may create a custom sort menu that does not include this salary sort.

When defining a sort menu, you must return a valid sort number with each selection contained in the developer-supplied menu.

View Password

Contains the 3 alphanumeric character password for the view.

Last Change Date

Displays the date of the last change to the selected View OW.

Create Date

Displays the date of creation of the selected View OW.

OPENworkshop View Database Maintenance

For more information about view maintenance, see CONNECT VIEW in the Dictionary-IV User Guide.

OPENworkshop View Appearance

For more information about view maintenance, see CONNECT VIEW in the Dictionary-IV User Guide.

Dictionary-IV Views

Views Dictionary-IV displays all Dictionary-IV views in all libraries. Starting with version 8.4.1 you can only Rename, Delete, and Copy these views. They are used with PRINT VIEW in Script-IV.

When you do a CONNECT VIEW to a Dictionary-IV View and the OPENworkshop View does not exist, the Dictionary-IV View is used as a template to display an OPENworkshop View. When you save the View, from that same CONNECT VIEW, an OPENworkshop View will be created and saved. For more information about changing the appearance of or performing maintenance on an OPENworkshop View, see CONNECT VIEW in the Dictionary-IV User Guide.

If you are operating in a Multi-Language environment see Multi-Language in the Dictionary-IV Administrator Guide.

Selection

Select **1-Edit** from the Dictionary-IV Development Menu or press **F1** from any Dictionary-IV menu. The system displays the Class pop-up menu.

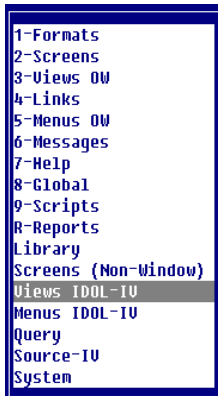

Select **Views Dictionary-IV**.

Views Dictionary-IV

F1 or F2 Edit/Display view F3 - Print (Change name)-Allows Copy or Rename

> 4GL Views <

View Name	Description	Link Name	K	D	D	U	C	B	C	Uw	Help Name	So Menu
4GCLERR	Compile Error View	4GCLERR	Y	Y	Y	Y	N	D	F	E		
4GPROG	> Script Definitions <	4GPROG	N	N	Y	Y	N	D	F	E		
4SCUST	Customer file	4SCUST	Y	Y	Y	N	N	D	F	E		
4SINVEN	Inventory file	4SINVEN	N	N	Y	N	N	D	F	F		
4SSLRP	Sales rep file	4SSLRP	N	N	Y	N	N	D	F	F		
8DCUST	Customer file	8DCUST	Y	Y	C	B	Y	R	E	Y	EF B	
8DDATA	Demo Data	8DDATA	N	N	Y	Y	N	D	F	E		
8DINVEN	Inventory file	8DINVEN	Y	Y	Y	B	Y	R	E	Y		
8DNUMS	Numeric Type Test	8DNUMS	Y	Y	Y	Y	N	D	F	E		
8DNUMS1	Numeric type 1 thru 5	8DNUMS	N	N	Y	N	N	D	F	F		
8DNUMS2	Numeric Type 6 thru 10	8DNUMS	N	N	Y	N	N	D	F	F		

View name

Components of Dictionary-IV Views

The Dictionary-IV view is composed of the header information and a listing of the existing views.

Dictionary-IV View Header Information

The header information consists of existing view names, view descriptions, link name, and view specifications as defined in the View definition.

View Names

From 3 to 8 characters for the view name. You can copy or rename a view by typing over the View Name.

Description

Type up to 40 alphanumeric characters for the view description.

Link Name

Type from 3 to 8 alphanumeric characters for the link to be used for this view.

Dictionary-IV View Detail Information

Once you have copied, or renamed a view, you may change the view specification. You can press **F9** to display and edit the view Specifications window.

Key Changes (KC)

Controls the ability to add and delete records and to use **F8** CHANGE, DELETE, COPY, and MOVE commands in a view. Select one of the following:

Y Allows changes to the key fields in the view.

N Does not allow you to change the key fields.

Data Changes (DC)

Controls the ability to add and delete records and to use **F8** CHANGE, DELETE, COPY, and MOVE commands in a view. Select one of the following:

- Y** Allows changes to the non-key fields in the view.
- N** Does not allow you to change the non-key fields.

Display Headings (DH)

Turn on or off the view headings. Select one of the following:

- Y** Allows you to display the headings.
- N** Does not display the headings.

View Changes (VC)

Controls the ability to delete or insert columns or to save a view. Select one of the following:

- Y** Allows view specification changes.
- N** Does not allow view specification changes.

Sort Changes (CS)

Turn on or off the ability to use **F5** Sort to select a different sort sequence pattern. Select one of the following:

- Y** Allows view sort changes.
- N** Does not allow view sort changes.

Border Heading (BH)

Contains view window heading specifications. The headings always display in the top border of the view window. Select one of the following:

- D** The view description is centered in the top border.
- V** The eight-character view name is displayed in the left-most top border.
- B** Both the eight-character view name and description are displayed in the top border.
- N** No headings display in the top border.

CR Mode (CM)

Defines the action of the **Enter** key while in the view. Select one of the following:

- F** Enter the normal field edit mode.
- S** Enter screen maintenance.
- s** Enter screen maintenance and return to View after record is edited.
- E** Exit the view.

Cursor Type (CT)

Defines the view lightbar specifications. Select one of the following:

- C** One character cursor marks the column/row intersection.
- E** Full field lightbar marks the column/row intersection.
- F** The full row is marked with the lightbar.

View Password (Vw Pwd)

Contains the 3 alphanumeric character password for the view.

Help Name

Contains the name of the help module, which provides the text to use for the view under the application help option.

Sort Menu Name

Contains the name of a menu to be used in place of the default selection pop-up menu. This menu can be more application specific than the default sort selection menu.

Example:

In an employee file you may decide to restrict a salary sort from the current operator. You may create a custom sort menu that does not include this salary sort.

When defining a sort menu, you must return a valid sort number with each selection contained in the developer-supplied menu.

Last Change Date

Displays the date of the last change to the selected Class definition.

Create Date

Displays the date of creation of the selected Class definition.

Dictionary-IV View Database Maintenance

For more information about view maintenance, see **CONNECT VIEW** in the Dictionary-IV User Guide.

LINKS

Links are Dictionary-IV interfaces to a data file and associated dictionary definitions. It may be used in scripts, reports, queries, and maintenance.

Script-IV	Includes commands to OPEN a link; READ, ADD, DELETE, or CHANGE records; and CLOSE the link.
Report-IV	Uses a link to access data files needed to produce the report.
Query-IV	Uses a link to access data files needed to produce the query.
Database Maintenance	Allows you to maintain the data file with a screen or view by specifying the link.

Security

A password can be specified for the link in order to restrict access to the link and data file from all but those with knowledge of the password. This feature is active in database maintenance, Report-IV, and Query-IV.

Terminal ID and Operator ID screening can also be specified in a link to define restrictions to the link in database maintenance only. An indicator is used in the link to enable or disable all audits performed on the data file. This feature allows you to keep track of the maintenance performed on individual fields in the file in database maintenance only.

Security Function of a Link in Database Maintenance

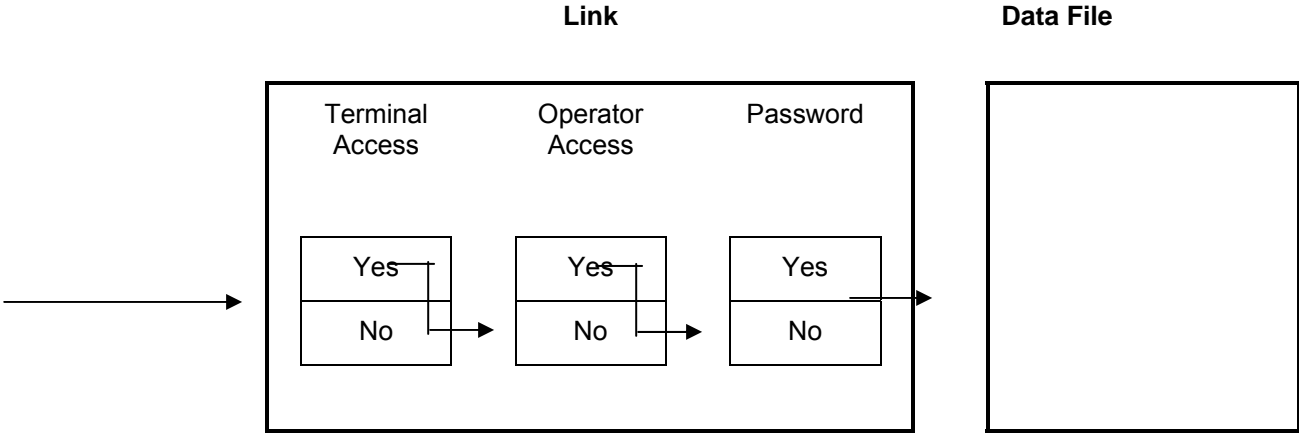

Function of a Link

Links are an integral part of Dictionary-IV. This section provides an explanation of the function of a link.

Primary Function

The primary function of the link is for access to a data file.

In a 3GL environment, you may access the data directly from the data file, and you must understand and control the layout of the file. There are few, if any, controls on access to the file.

In Dictionary-IV, the interface to the data file is defined in the System Dictionary as a link. The link controls access to the data file. The primary specifications in the link are the format, data file, sort file, sort definition, text file, Screen definition, and View definition. For more information on sorts, see Sort Window. These are used when a link is accessed.

Primary Function of a Link

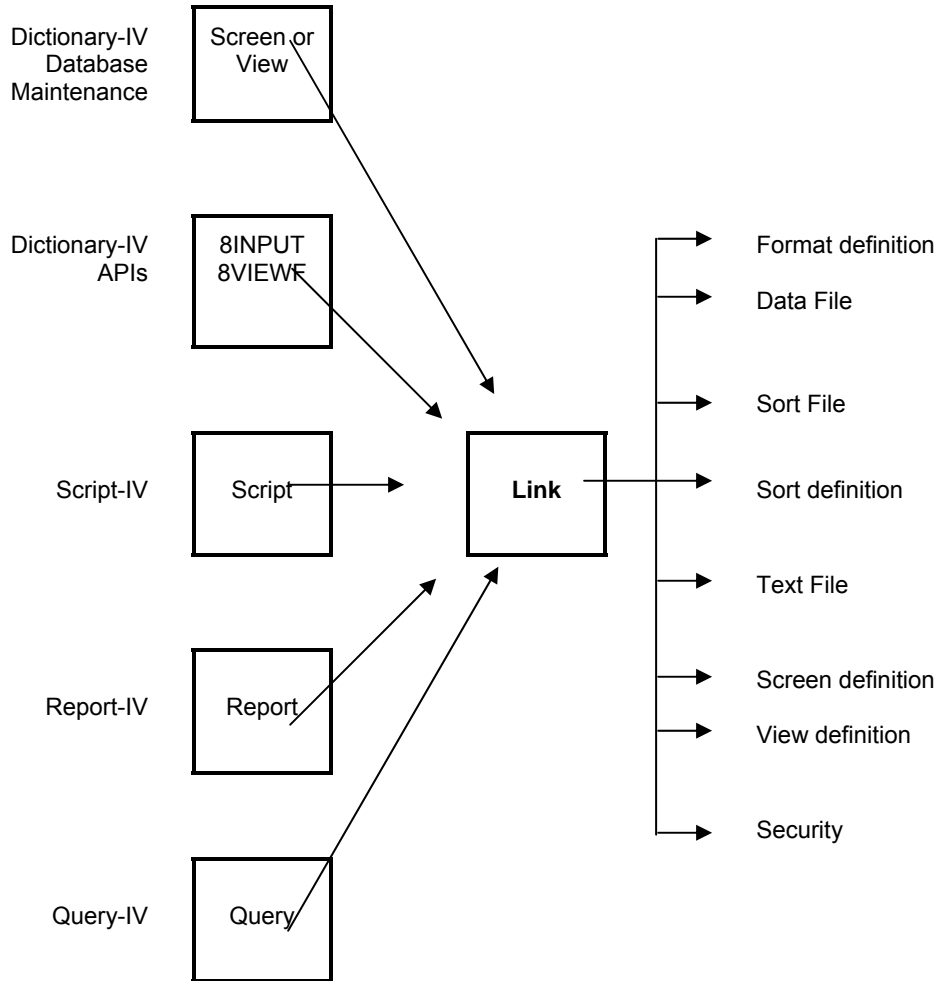

The format name is used to determine the format of the information in the data file. The secondary key or cross-index sort definitions are used to access the records in the data file in an order other than primary key order.

Depending on the file type, secondary keys may be stored in a separate Sort file.

Structural Integrity

The data file, sort file, sort definitions, text file, and text records are tied together within a link because they are all based upon the Format definition. The format defines the record structure of the data file and is used as a basis for the sort definitions, and therefore as a basis for the secondary keys in the sort file.

Direct files have separate sort files, MSORT and TISAM files do not. MSORT and TISAM files have separate text files, Direct files do not. For more information, see the Thoroughbred Basic Developer Guide.

This structural interdependence requires that you maintain integrity in your links. The link cannot function logically if you link together physically unrelated definitions or structures.

Physically Related Structures for Direct Files

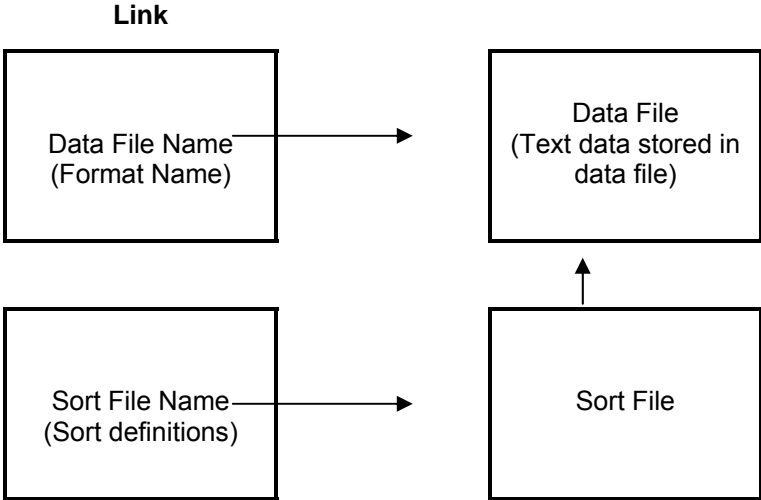

Physically Related Structures for MSORT and TISAM Files

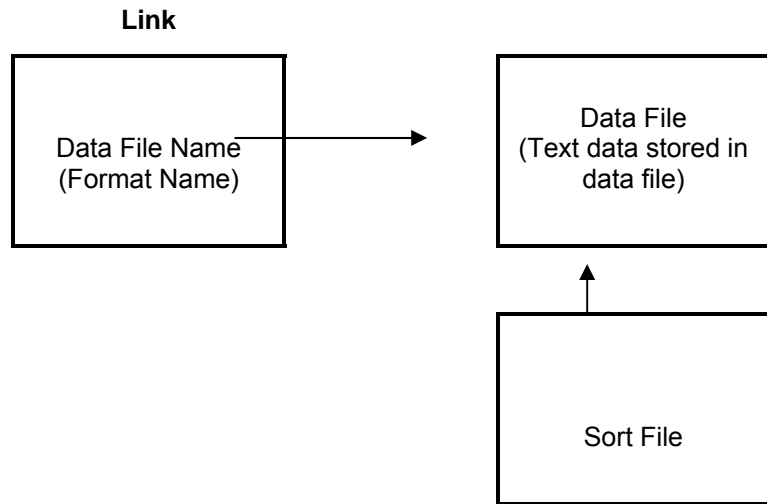

You must maintain structural integrity within a link as well as between links. In a specific link you cannot properly access data if you use a data file and format that are unrelated to each other. In two or more links, you must maintain a 1-to-1 correspondence between the link, data file, sort file, and sort definitions.

If you link together one data file (one format) and two different sort files or two sets of sort definitions in two or more links, you will not be able to properly access the data using a sort.

Multi-format Files

The 1-to-1 correspondence is not required in a multi-format file (a single data file that has more than one record layout).

A data file that stores records having more than one type of format is called a multi-format file. For example, if customer orders are stored in one data file, the file may contain order header records and order detail records.

Or perhaps you may store several lists of valid values in one lookup file.

Thoroughbred Dictionary-IV supports multi-format files when a preset key value is preset in the key area.

Create a multi-format File

Define preset key-prefix fields in the formats.

- Add a preset key field to the format. Key presets work best if they are placed at the beginning of the key. Typically key presets are found in the beginning of the key area. Using this methodology, Dictionary-IV will only access a range of records using the preset value.
- Define the security value for the preset key fields as 3,0.
- Specify a different default value for the preset key fields.
- Define all other attributes the same for the preset key fields (including length and padding).

Define the multi-format file linkage

- Define one link for each format.
- Specify a different format name in each link.
- Specify a different sort file name in each link.
- Specify the same data file name in each link.

Multi-format File Linkage for Direct Files

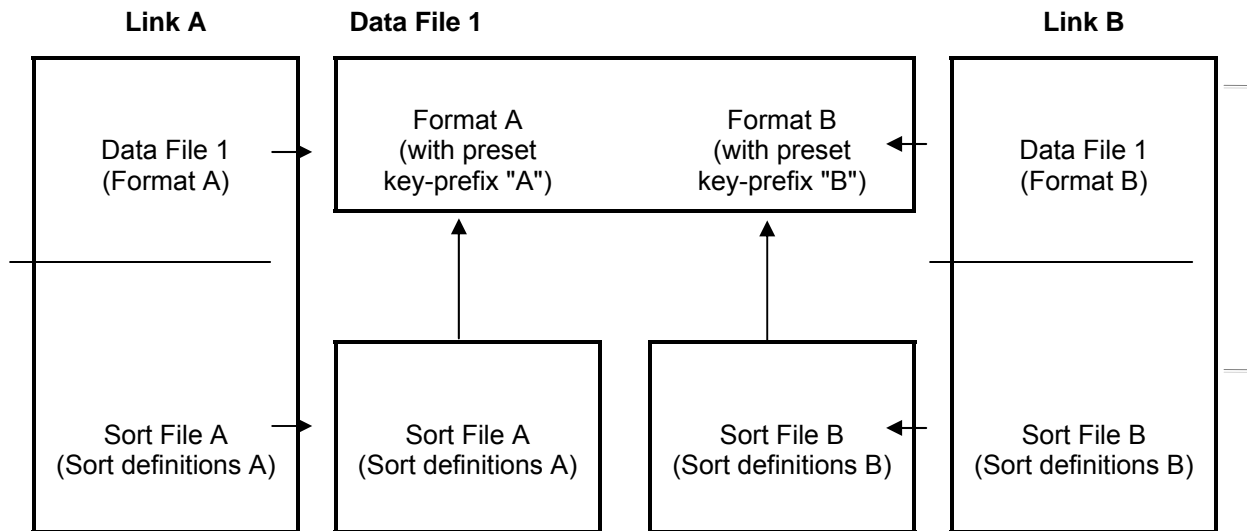

Operation

Each link is treated as a logical data file in Thoroughbred Dictionary-IV. When you access the link, you access only those records in the physical data file with the format specified in the link.

Correct 1-to-1 Linkage

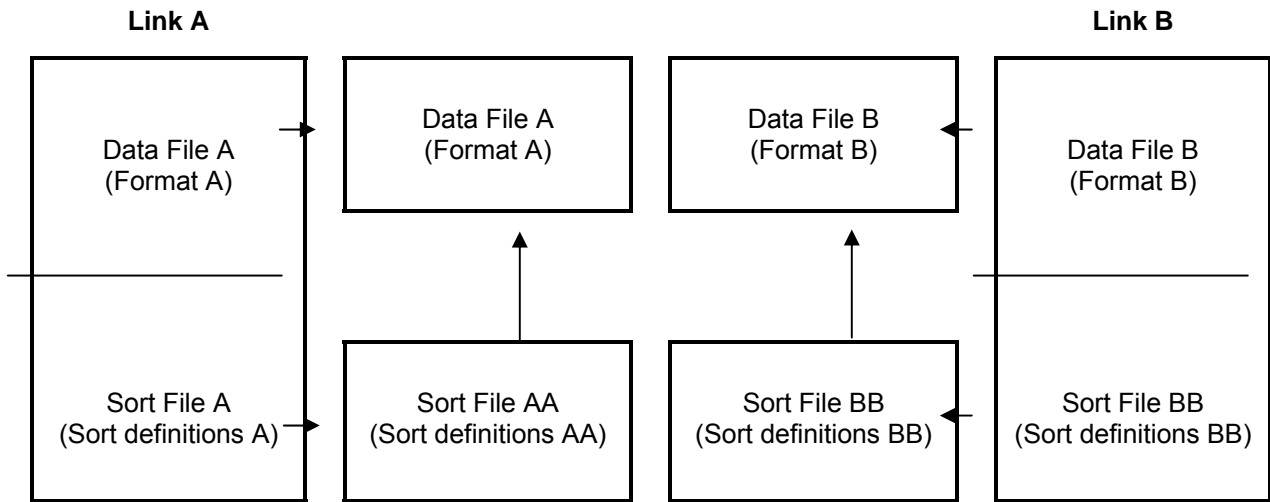

Incorrect Linkages for Direct Files

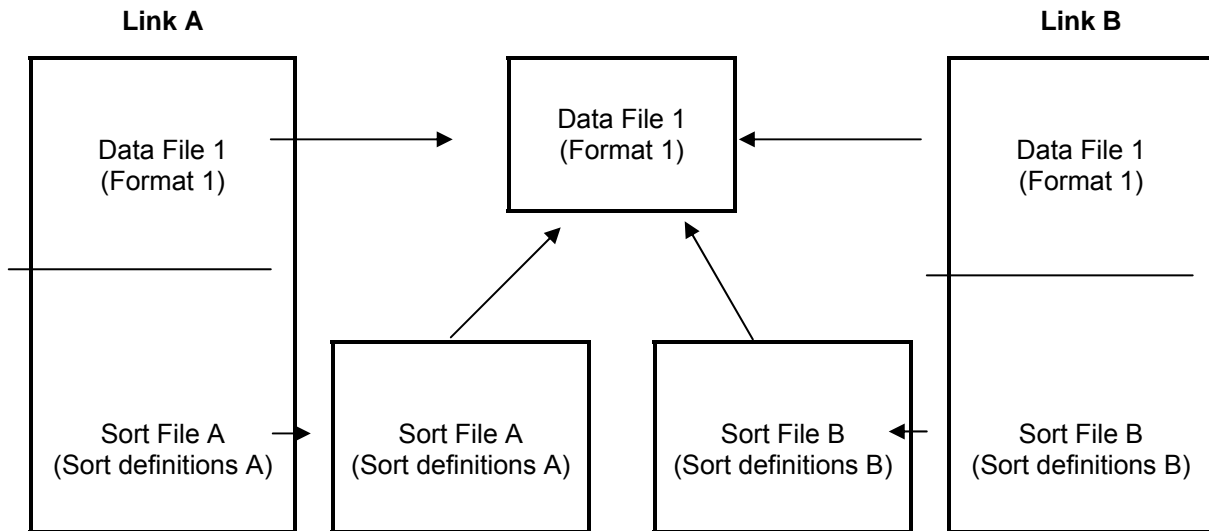

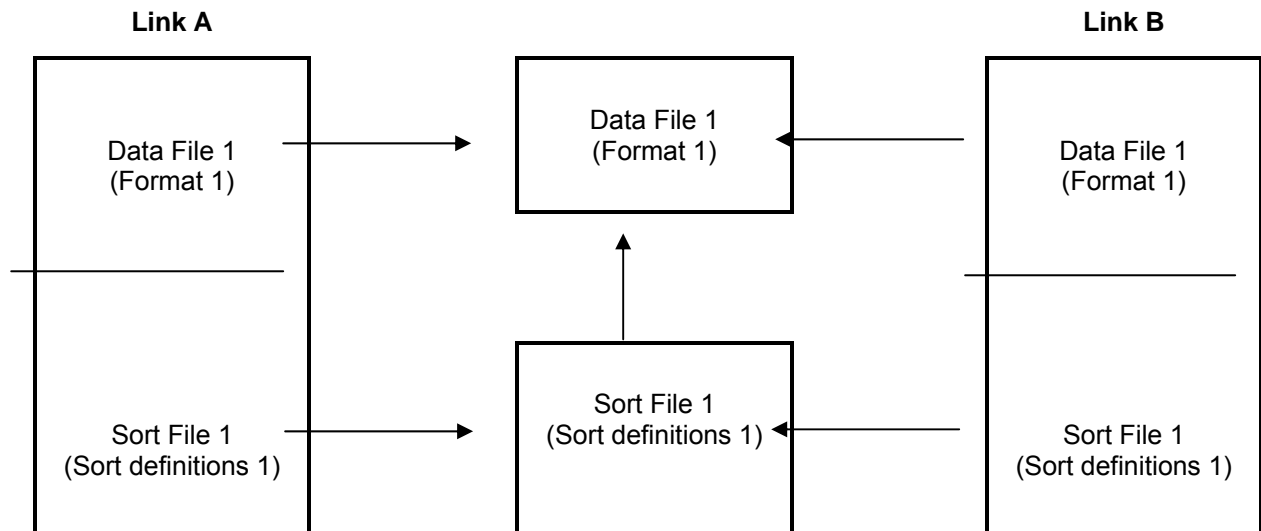

Using Dictionary-IV database maintenance to create the link for you automatically can help to maintain structural integrity.

Other Functions in Database Maintenance

In addition to the primary features of a link, several additional features are available in Dictionary-IV Database Maintenance. These include data security, the ability to specify a screen or view for maintenance, define the data file type and size, and define the Server ID.

Selection

Select **1-Edit** from the Dictionary-IV Development Menu or press **F1** from any Dictionary-IV menu. The system displays the Class pop-up menu:

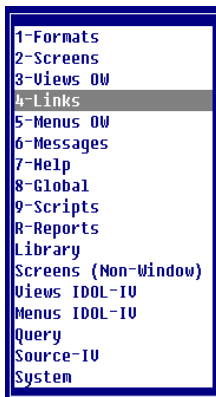

Select 4-Links

Link View

Link Name	Format Name	Description	DataFile Name	F T	SortFile Name (8)	Link I/O Trigger	View Name
4GCPLERR	4GCPLERR	Compile Error File	4GCPLERR	I			
4GCPSEL	4GCPSEL	4GL - Compile Select F	4GCPSEL	I			
4GLP		Printer LP	LP	I			
4GP1		Printer P1	P1	I			
4GP2		Printer P2	P2	I			
4GP3		Printer P3	P3	I			
4GP4		Printer P4	P4	I			
4GP5		Printer P5	P5	I			
4GP6		Printer P6	P6	I			
4GP7		Printer P7	P7	I			
4GP8		Printer P8	P8	I			

The standard editing keys are active in the Link definition header and the Sort definition window.

From this Link View you can access the Link Name, Format Name, Data File, Sort File, Link I/O Trigger (if you have OPENworkshop installed), View Name, and Screen Name.

Link Name

Press **F1** to edit the selected Link. For more information, see Link View Detail Information: **F1** Edit the Link in this document.

Format Name

Press **F1** to edit the format of associated with the selected Link. For more information, see Link View Header Information.

Data File Name

Press **F1** to modify the data file. For more information, see File Transfer and Expand in the Thoroughbred Basic Utilities Manual. Press **F2** to display the data file information. For more information, see Display File Parameters in the Thoroughbred Basic Utilities Manual. Press **F3** to validate the Format Name, Data File Name, Record size, and File Size.

Sort File Name

Press **F1** to modify the sort file. For more information, see File Transfer and Expand in the Thoroughbred Basic Utilities Manual. Press **F2** to display the sort file information. For more information, see Display File Parameters in the Thoroughbred Basic Utilities Manual.

Link I/O Trigger

Press **F1** or **F2** to Edit/View Methods. You must have OPENworkshop installed to perform this edit/view. For more information, see the OPENworkshop Reference Manual.

View Name

Press **F1** to edit the View. If a View Name does not exist the system prompts you through creating one. Press **F2** to display the View.

Screen Name

Press **F1** to edit the Screen. If a Screen Name does not exist the system prompts you through creating one. Press **F2** to display the Screen. Press **F3** to perform Screen file maintenance.

Components of Link Views

The Link definition is composed of two parts: the header information and the Sort Window.

Link View Header Information

The Link View header information consists of the Format Name, and Description.

From the Link View you can edit the following by pressing **F1** in the appropriate field:

- Format Name
- Data File Name
- Sort File Name
- Link I/O Trigger (This option is available only if you have installed OPENworkshop.)
- View Name
- Screen Name

Link Name

Type from 3 to 8 alphanumeric characters for the name of this link and press **Enter**. This field is mandatory.

Characters one and two are the Library name. Characters three through eight are the link name.

For more information, see Class definition in this document, which provides a file naming convention you may implement.

Press **F1** (or **F2** to edit the link). The system displays the Link Name, Link Description, Last Change Date, and Create Date. For more information, see Edit the Link.

Format Name

Type from 3 to 8 alphanumeric characters for the name of the Format and press **Enter**. Press **F1** to edit the Format, press **F2** to display the Format View, or press **F3** to display the Format.

Description

Type up to 40 alphanumeric characters for the description of this link and press **Enter**. This field is optional.

Link View Detail Information: F1 Edit the Link

Password

Type from 1 to 3 alphanumeric characters for a password and press **Enter**. If the system security is active and a link password is specified, the password is required to access the link during database maintenance. This field is optional.

Terminal Access

Use this field to allow access to or restrict access from the terminals. The syntax is the same as Menu definition.

0, term-code [,term-code]...

0 allows access to the specified terminal codes.

term-code defines the 2 alphanumeric character terminal codes for the terminals that can access this selection.

1,term-code [,term-code]...

1 denies access to the specified terminal codes.

term-code defines the 2 alphanumeric character terminal codes for the terminals that cannot access this selection.

If this is left blank all terminals have access. Terminal access is applicable to scripts.

For more information about other types of security (i.e. group security), see the OPENworkshop Reference Manual under Security.

Examples:

0,T0,T3

Allows access for terminals T0 and T3.

1,T1

Denies access for terminal T1.

Operator Access

Use this field to allow access to or restrict access from the operators. The syntax is the same as Menu definition.

0, oper-code [,oper-code]...

0 allows access to the specified operator codes.

oper-code defines up to 3 alphanumeric characters for the codes of the operators that can access this selection.

1,oper-code [,oper-code]...

1 denies access to the specified operator codes.

oper-code defines up to 3 alphanumeric characters for the codes of the operators that cannot access this selection.

If this is left blank all operators have access. Operator access is applicable to scripts.

Examples:

0,JBT,NRS

Allows access for operators JBT and NRS.

1,JMG

Denies access for operator JMG.

File Type

Specifies the file type to be created or used. Select one of the following:

I Dictionary-IV file type (Direct, Indexed, or Sort).

M MSORT file (must have key fields defined).

T TISAM file (must have key fields defined).

U Text file. Cannot perform maintenance on this file type.

The value of this field cannot be changed if:

- Sort definitions exist.
- The data file field contains the file suffix character (@).
- The data file exists and the file type is different than the new value being entered.

To specify an auto expanding direct or sort file, set the file type to I and the number of records to 0.

Number of Records (Nnbr Recs)

Specifies the number of records used to create a data file. Valid entries range from 0 to 2,147,483,647. The default value is 300 records. To specify an auto expanding direct or sort file, set the file type to I and the number of records to 0.

Format

Type the 3 to 8 alphanumeric character name for the Format definition contained in this data file and press **Enter**. Press **F2** for a lookup of available Format definitions.

Data File

Specifies the Data file name to be accessed by the Link.

Press **F2** for a lookup of currently referenced data file names.

To perform an integrity check and a clean up of secondary key files, press **F5** on the data file name. Any extra secondary keys are removed; any missing secondary keys are added. This test is repeated until no more errors are found. This can be run without requiring exclusive use of the data file.

When the suffix character is entered as part of the file name, the current value of the Dictionary-IV FILE-SUFFIX variable will be substituted in place of the file suffix character.

Be sure that the length of the file name does not exceed 14 characters after the file suffix value is substituted.

MSORT and TISAM file names contain data records that end with .dat suffix. Be sure that the length of the file name does not exceed 14 characters after the file suffix value is substituted.

Sort File

Specifies the name of the file containing the file's sort keys. The default name is the Data file name plus a .sk suffix.

The default is applied in the link when sorts are created (press **F1** or **F8** from the sort editor) and the Sort file name is blank.

This field is only entered for Dictionary-IV file types (I). For MSORT (M) and TISAM (T) files, the Data file name is copied into this field when sorts are built. It contains the sort key index and may have an .idx suffix.

If your TISAM files are compatible with ISAM Informix SE and Focus COBOL they may require the extension on the file name (for example, CUST.idx).

Press **F2** for a lookup of sort file names used by existing links.

The sort file will not exist until you create and build your first sort. For more information, see the Sort Window.

Text File

Type the 3 to 8 alphanumeric character name of the data file to store text fields for MSORT and TISAM file types and press **Enter**.

When a data file is created, this text file will be created. The default name will be the data file name with the extension .TXT.

This field is only entered for MSORT and TISAM (C-ISAM) file types.

Press **F2** for a lookup of currently referenced text files.

Screen File Maintenance

Type the 3 to 8 alphanumeric character name for the screen to be used when the Link is referenced for single-record maintenance. Press **Enter**.

This field is optional and if it is left blank or an invalid screen is entered, then a default screen is automatically generated from the Data Names in the Format definition.

Press **F2** for a lookup of available Screen definitions.

View File Maintenance

Type the 3 to 8 alphanumeric character name for the view to be used when Link is referenced for multi-record maintenance. Press **Enter**.

This field is optional and if it is left blank or an invalid view is entered, then a default view is automatically generated from the Data Names in the Format definition.

Press **F2** for a lookup of available View definitions.

Audit

Enables or disables audits for this Link. Changes made using CONNECT VIEW, or CONNECT SCREEN are recorded in the specified audit file(s).

Audit Function of a Link in Database Maintenance

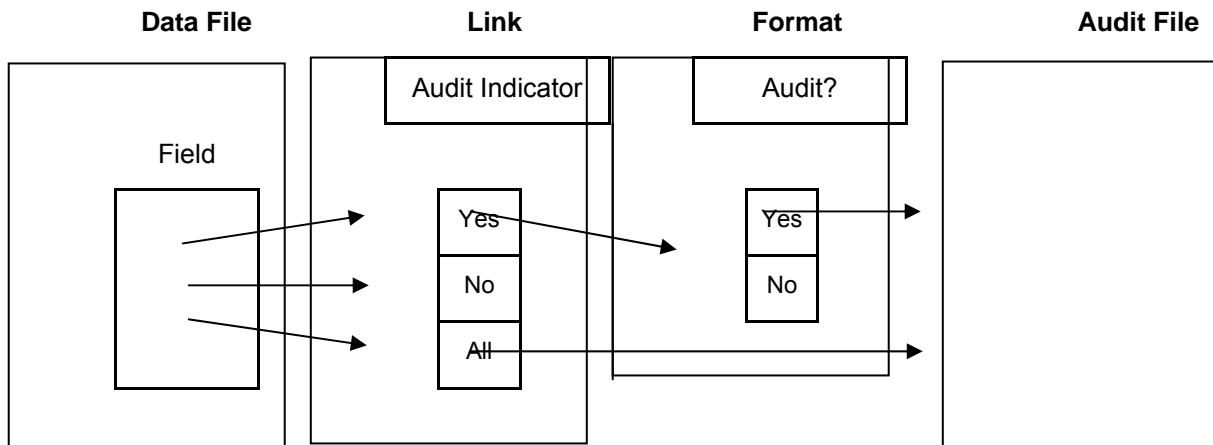

Select one of the following:

- A** Audits all Data Names in the format. The data indicator (0-7) will be ignored. The default audit file (IDAUDT) is used for elements not specifying an audit file.
- Y** Audits only Data Names with audit specifications in the format.
- N** Disables all audits for this Link.

I/O Trigger

This field is available only if you have OPENworkshop installed. Defines the name of a Script of Basic method that will be executed each time an update is required to the data file specified in the link. The VIEW class, SCREEN class, and SCRIPT UPDATE directive will execute this method for all updates requested of the class or directive. For more detailed information see the I/O Trigger on-line help.

File Suffix Method

This field is available only if you have OPENworkshop installed. A file suffix method can be used to build the file suffix that is contained in the global object #IDSV.FILE-SUFFIX. The file suffix method is specified in the link header and, when specified, will be executed prior to applying a file suffix when a link is opened. When executed, the link name being opened will be passed in entry 1 of a MSG\$ array.

```
CALL "file-suffix-method", MSG$[ALL]
```

```
MSG$[0]      Return status.  
[1]      Link name to be opened.
```

If the file suffix method can be found it will be executed, if not, it will be ignored and LINK open will continue as if a file suffix method was not specified. Any value in entry [0] is all right.

Server ID

Type the 2 alphanumeric character designation for the server system where the data file resides. This value is configured in the IPLINPUT file. Press **Enter**.

In order for a file to be recognized as a server file by the system, the file type must be set to **M** and valid information must be entered in Server ID and Table Name fields. If the Server ID or Table Name is blank, the file will be considered a local file.

TS DataServer must be enabled to access this field. For more information, see the TS DataServer documentation.

Server Table Name

Type up to 30 alphanumeric characters for the name of the physical file that is accessed in the server native environment and press **Enter**. This field is only accessible for links that reference server files.

TS DataServer must be enabled to access this field. For more information, see the TS DataServer documentation.

Sort Window

The Sort window allows you to define sorts.

The Sort command creates secondary keys (cross-indices) that are used to access and display records in an order other than primary key order. The Sort command can specify a Data Name, a part of a Data Name, or combinations of Data Names. It can also specify ascending or descending order and case-sensitive or case-insensitive sorting. Depending on the file type, secondary keys may be stored in a separate Sort file.

Save the Link

After entering the header information, the system prompts for saving the link (or modifications).

Link definition follows the standard definition maintenance prompts with the following exceptions.

If a duplicate data file name is found and the format does not have a preset key-prefix (multi-format file), then a warning message is displayed:

WARNING: Link `XXXXXX' uses this file. Continue anyway?

Select one of the following:

Y To ignore this warning and resolve the conflict later. The link will be saved.

N To return to the link without saving it.

When you complete the header information the system prompts:

Do you want to edit sorts?

Select one of the following:

Y The system displays the Sort window.

N The system accepts the Link definition and you can continue to enter information.

If you select **Y** and the data file has not been created, the system prompts you through its creation. For more information about the Data file, see definition Maintenance in this document.

Creating Sorts

In the following sections you will find the function keys and the command syntax available in the Sort Window.

Quick Key Reference (Sort Window)

Key	Description
F1	Builds a newly defined sort. To delete a SORT statement, remove it from the window and press F1 . The changes to the sorts are updated in the link and the sorts in the file are automatically removed.
F4	Exits the Sort Window. Changes made since the last build (F1 or F8) are lost.
F6	Displays on-line help.
F7	Generates a default SORT0 statement. The default is built using all Data Names in the format, which have the key indicator, set to Y . The statement is constructed in the same sequence as the key fields appear in the format. For more information, see SORT0.
F8	Rebuilds all sorts.
F10	Displays the Data Names for this format. From the Data Name window, press F7 to toggle between the display of Data Names and the display of the current language data descriptions.

Sort Command Syntax

Define your sorts in the Sort window.

Sort definition Window

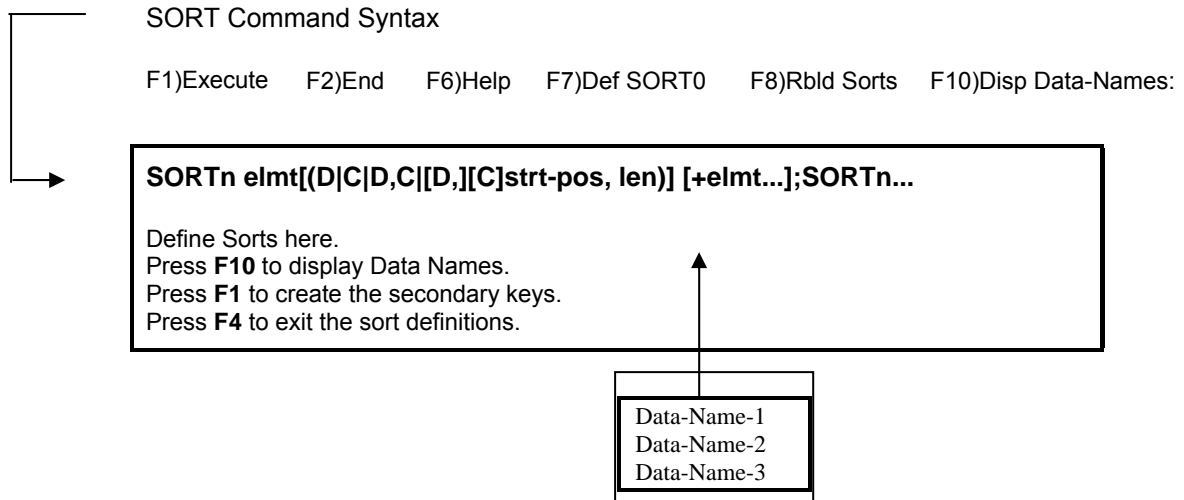

Use the following syntax:

```
SORTn elmt[(D|C|D,C|[D,][C,]strt-pos, len)]  
[+elmt...]; SORTn...
```

SORT is the keyword.

n is numeric value from 0 to 99 to identify the definition. Sort 0 defines the primary key order.

elmt is the Data Name from the Format definition to be used as a secondary key or part of a secondary key.

D (optional) is descending order. The default is ascending order.

C (optional) is case-sensitive. The default is case-insensitive. For MSORT and TISAM files, sorting always case-sensitive.

strt-pos is the position to begin the substring. (Cannot be used with D or C options.)

len is the number of characters in the substring.

When the D and/or C options are used, the substring must follow the D/C option.

Examples:

SORT1 CUS-CODE

Sorts by the data in the CUS-CODE field. By default, the sort is in ascending order and is case-insensitive. SMITH, smith, and Smith all sort as smith.

SORT2 SLSMN-CODE(D,C) + CUST-CODE(C,D,1,2)

Sorts by the data in the SLSMN-CODE field followed by the data in the first two characters of the CUS-CODE field. Both fields are sorted descending order and case-sensitive. SMITH, smith, and Smith sort differently.

SORT3 BAL-DUE(D)

Sorts by the data in the BAL-DUE field in descending order. In this case the highest value in the field appears first in the order.

SORT4 ITEM-CODE(2,1) + INDEX

Sorts by the second character of the ITEM-CODE field followed by the contents of the INDEX field.

SORT5 PHONE-NUM(D,1,3)

Sorts by the first three characters of the PHONE-NUM field in descending order from the highest to lowest value.

SORT0 KEY-3 + KEY-4 + KEY-2 + KEY-1

Defines the order of the primary key for the file.

SORT0

Non-contiguous primary keys must be defined using a SORT0 statement. Press **F7** to generate a default SORT0 containing all key fields in format.

When a SORT0 statement exists or the format contains non-contiguous key fields, CONNECT VIEW or CONNECT SCREEN is used to maintain the file instead of the standard file maintenance system.

The following are special rules for SORT0:

- The SORT0 statement must contain all Data Names that have the key indicator set to **Y** in the format.
- The strt-pos, len, C, and D options are not valid in SORT0 options.

Sort Description

Subscripts

The strt-pos, len, D, and C options cannot be used with a multiple occurrence element.

Sort File Names

For Dictionary-IV file types (Direct, Indexed, and Sort files), when no sort file name is specified in the link, the sort file name defaults to the first 12 characters of the data file name specified in the link plus sk.

Example:

Data file = PRMASTERFIL1; Sort file = PRMASTERFILEsk

A data file must be unique in the first 12 characters if sort files are to be defined. SORT0 is reserved for the default (primary key access).

Case Sensitivity

Specifying a sort as case-insensitive (default) only affects the sorting of the characters A-Z and a-z. Case-insensitive sorting has no effect on numbers or special characters.

Sort Performance

The time it takes to rebuild or update sorts depends on:

- The number of records in the file.
- The number of sort definitions in the link.
- The total length of each sort definition.

To maximize performance, remove unneeded sorts and use subscribing to reduce the length of sorts on large Data Names.

An example is sorting on a 35-character CUST-NAME field. SORT1 CUST-NAME and SORT1 CUST-NAME (1,10) may achieve almost identical results (depending on the nature of the data). CUST-NAME (1,10) is faster and uses 25 fewer bytes for each record in the data file.

Saving Sorts

Sorts cannot be saved (**F1** or **F8**) from multi-record maintenance. Use Link definition maintenance to save changed sorts.

Multi-record Maintenance

From single- or multi-record maintenance press **F5** to select a sort number. Sort definition changes cannot be made from file maintenance.

MSORT and TISAM Files

Since sort updates on MSORT and TISAM files do not print the current key on the screen, the terminal may appear unresponsive until the update is complete.

MSORT and TISAM files sort data exactly as it is stored in the file. As a result, all MSORT and TISAM sort definitions are case-sensitive, even if the **C** option is not specified.

Non-unique secondary sort keys can cause problems with applications that use keyed access on secondary sorts. It is recommended secondary sort keys be unique. For example, using the sample format UTCUST and sorting with the REP-CODE field you could define the following sort:

SORT1 REP-CODE + CUST-CODE

This results in a unique key.

If no sorts exist in the link, and indexes already exist in the specified file, a set of sort statements is automatically built. They are based on indexes in the file.

Press **F1** to save the generated sort statements in the Link definition. At this point the sort definitions are saved in the link. The system prompts:

Generate defined sorts?

Select one of the following:

Y To rebuild the sorts in the data file.

N To avoid rebuilding the sorts.

Once the sorts are saved, they can be accessed by all components of Dictionary-IV (Script-IV, Report-IV, and Query-IV).

MENUS

OPENworkshop and Dictionary-IV provide an independent Menu Management System that can be used for software execution and system control. It provides an interface to application software.

The Menu Management System is not used directly in scripts.

A menu is a listing of selections. These selections can include running programs, starting special procedures, starting database maintenance, calling other menus, or going to software other than Dictionary-IV. For more information on creating pop-up menus, see Help definition in this document.

Each selection is associated with a code and the information necessary to initiate the selection.

The Thoroughbred menu system makes on-line help for selections definable and controls access and use of menus and selections.

To create a menu you need to define three Classes: a menu, a screen, and a format.

Menu definition

Define each possible menu selection and the action that will be taken when the user enters this selection.

Screen definition

Create a user interface screen, which displays the selection codes as well as one selection input field. It may be a window or non-window screen.

Enter the list of menu selections and description of the screen. You must define one data field using the Data Name from the format.

For more information, see Screens in this document.

Possible Menu Selections

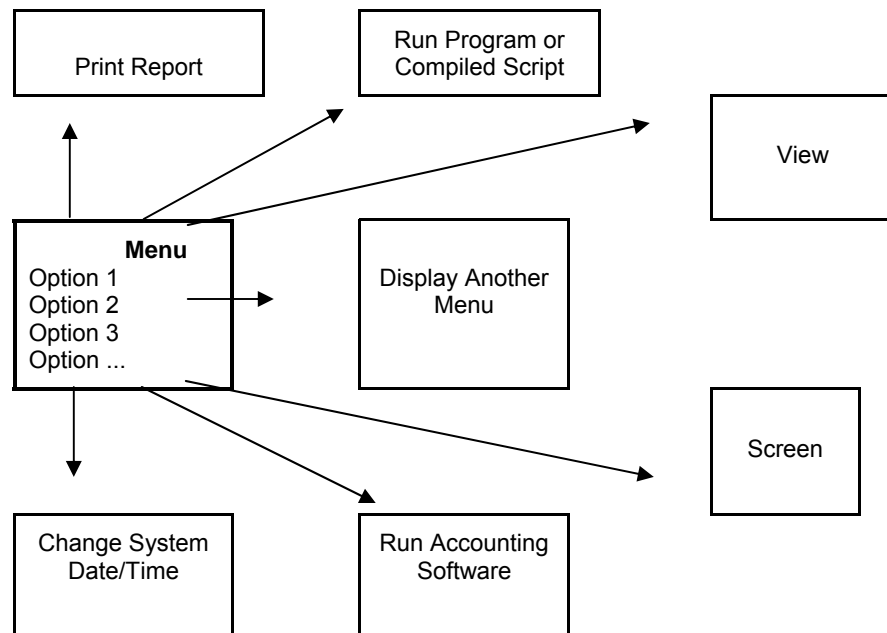

Format definition

A logical format is needed for the menu screen. This format has only one data name, which is used for the collection of the menu selection. You can use the single Data Name format called IDMENUIN, which is provided in Dictionary-IV for menus, or create your own. If you create your own format, only the Data Name and length are required.

For more information, see Formats in this document.

OPENworkshop Menus

Selection

Select **1-Edit** from the Dictionary-IV Development Menu or press **F1** from any Dictionary-IV menu. The system displays the Class pop-up menu:

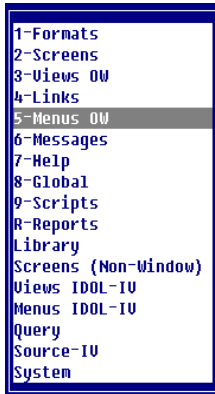

Select **5-Menu OW**. The system displays the OPENworkshop Menu View.

OPENworkshop Menu class

F1 - Edit F2 - Display F3 - Print (Change name) - Allows Copy or Rename.

Menu		L		S		Description		Hdr	LastChng	Create	Nbr
Name								Typ	Date	Date	Recs
C									02/27/98	02/25/98	2
8DBASIC	1						8.n Enhancements		02/27/98	12/23/89	19
8DBDIR	1						Directive Index		02/27/98	12/26/89	116
8DBDIR54	1						Trans Processing 8.2		02/27/98	08/21/91	10
8DBDIR55	1						FORMAT..... 8.2		02/27/98	08/21/91	7
8DBDIR59	1						OPEN OPT= 8.2		02/27/98	09/14/93	6
8DBDIR66	1						SET		09/04/96	09/14/93	12
8DBDIR6P	1						OPEN.....		09/04/96	05/05/94	7
8DBDIR6W	1						WINDOW options		09/04/96	08/16/91	27
8DBFATRM	1						ATR 8.2		09/07/96	09/10/91	4
8DBFCUTM	1						CUT 8.0		09/04/96	09/27/93	5

Components of OPENworkshop Menu View

The Menu definition is composed of three parts: header information, selection code (description), and selection specifications.

OPENworkshop Menu Header Information

The menu header information consists of the name and description of the menu, the name of the menu screen, the help module for the menu, and an optional password used for menu security.

You may enter the following information:

Menu Name

Type from 3 to 8 alphanumeric characters for the name of this menu. This field is mandatory.

Characters one and two are the Library name. Characters three through eight are the Menu Name.

For more information, see Class definition in this document, which provides a file naming convention you may implement.

LS

For internal use.

Description

Type up to 40 alphanumeric characters for the description of this menu. This field is optional.

OPENworkshop Menu Detail Information

Help Header Title Type (Hdr Typ)

This field controls the use of the Menu, screen description in the window's top border.

Select one of the following:

blank Screen description does not appear in the window title area.

C Screen description is centered in the top border of the screen's window.

R Screen description is right-justified in the top border of the screen's window.

L Screen description is left-justified in the top border of the screen's window.

The default is **blank**.

Last Change Date

Displays the date of the last change to the selected OPENworkshop Menu.

Create Date

Displays the date of creation of the selected OPENworkshop Menu.

Number of Records (Nmbr Recs)

Displays the number of records in the specified menu.

Creating/Editing OPENworkshop Menus

Press **F1** to create/edit an OPENworkshop Menu. For more information, see Pop-up menu help in this document.

Dictionary-IV Menus

Selection

Select **1-Edit** from the Dictionary-IV Development Menu or press **F1** from any Dictionary-IV menu. The system displays the Class pop-up menu:



Select **Menus Dictionary-IV**.

Components of Dictionary-IV Menu View

The Menu definition is composed of three parts: header information, selection code (description), and selection specifications.

Dictionary-IV Menus

F1 - Edit F2 - Display F3 - Print (Change name) - Allows Copy or Rename.

> IDOL-IV Menus <

Menu Name	Description	Screen Name	Menu HlpCde	Menu Pwd	Menu LastChng Date	Create Date
U:MENU	GUI Screen Demo	GUMENU			08/17/95	03/15/88
IDGLOBAL	IDOL-IV Global Menu Definition				01/05/98	11/08/91
IDMENU1	IDOL IV - Development Menu	IDMENU1	1M		11/17/97	10/18/88
IDMENU2	IDOL IV - Utility Selections	IDMENU2	1U		11/10/97	10/18/88
SLDelete	delete					01/23/98
UTMENU10	Control Menu	UTMENU10	MENU10		09/23/97	12/29/87
UTMENU11	Supplemental Utilities	UTMENU11	MN11		02/12/96	12/09/88
UTMENU12	Upgrade Menu	UTMENU12			09/23/97	01/26/94
UTMENU13	Multiple Spoken Language Utili	UTMENU13	MENU13		09/23/97	01/26/94
UTMENU20	IDOL-IV Control Menu	UTMENU20			05/07/97	05/19/94
UTMENU21	IDOL-IV Development Menu	UTMENU21			09/23/97	05/19/94

Dictionary-IV Menu Header Information

The menu header information consists of the name and description of the menu, the name of the menu screen, the help module for the menu, and an optional password used for menu security.

You may enter the following information:

Menu Name

Type from 3 to 8 alphanumeric characters for the name of this. This field is mandatory.

Characters one and two are the Library name. Characters three through eight are the Menu Name.

For more information, see Class definition in this document, which provides a file naming convention you may implement.

Description

Type up to 40 alphanumeric characters for the description of this menu and press **Enter**. This field is optional.

Dictionary-IV Menu Detail Information

Screen Name

From 3 to 8 alphanumeric characters for the name of the screen this menu will use for user interface.

A screen must be defined for user interface with this menu. If you have already created one you may enter it now. If you have not already created one you do not need to enter the screen name now.

Press **F1** to edit the screen.

Menu Help Code

Specifies an optional name, which designates the help to be displayed when you press **F6** at the menu selection prompt. The library in which the help is located is the same as that for the menu.

Type from 3 to 8 alphanumeric characters for the name of the help module. Press **F1** to enter or edit help.

Enter or edit your help text. You may then go to Help definition to change these default settings. For more information, see Help definition. This field is optional.

Menu Pwd

Type up to 3 alphanumeric characters for the password and press **Enter**. If the system security is active and a menu password is specified, the password is required to access the menu. This field is optional.

Last Change Date

Displays the date of the last change to the selected Dictionary-IV Menu.

Create Date

Displays the date of creation of the selected Dictionary-IV Menu.

Dictionary-IV Menu Editor

Menu Option (Opt)

This is a unique identifier for the menu items.

Entry Code

Use the selection code to initiate a menu selection.

The menu selection list displays a list of all of the selection codes and their descriptions. Only 18 are shown, but the list will scroll (up to 99) as you go past the last selection. The functions listed are available when you are in this area of the Menu definition screen.

Each menu selection specification displays the attributes of an individual menu selection code.

The following editing keys are available:

- | | |
|--------------------|--|
| Line Insert | Enters a new selection and adjusts the order of the existing selections. |
| Line Delete | Deletes the selection code and the specifications. The F2 key also performs this function. |
| F1 | Edits an existing menu selection and to enter the help definition window. |
| F2 | Deletes the selection code and specifications. Press F2 and the selection code and specifications are deleted. |
| F3 | Rearranges the existing order of the selections.
Type the number of the selection you want to move followed by a comma. Type the number where you want it moved and press Enter . The move actually does an insert before, and then adjusts. So if you move 3,4 or (3 to 4), the system will insert item 3 before item 4 and no changes will result from the move. |
| F4 | Saves and exits the Menu definition. |
| F5 | Changes the help window width.
The system prompts:
Help window width now xx, change to ___.
Type the new width and press Enter . The width may be from 2 to 74 characters. Once text is entered at the selected width, it is recommended that you do not change the width or text may be lost. |
| F6 | Displays on-line help. |
| F10 | Goes to another selection.
The system prompts:
Enter selection to go to.
Type a selection number and press Enter . You may have as many as 99 selections. |

Menu Selection Name

Type up to 30 alphanumeric characters for the selection code and description. Codes can be from 1 to 4 characters. The description is optional and must begin after column 4.

The description is invisible to the user, except when using Thoroughbred VIP.

Duplicate selections for uppercase and lowercase are not needed in a menu definition. During selection processing the system tries to locate the selection first in uppercase and then in lowercase.

Selection Type (ST)

Specifies the type of action to be processed when this selection is made. This is a required field. Select one of the following:

- A** (Uppercase) Executes database maintenance prompt (screen or view).
- C** (Uppercase) Executes specified CONNECT.
- c** (Lowercase) First creates an 80 x 24 window then executes specified CONNECT.
- D** (Uppercase) Executes change system date/time.
- d** (Lowercase) Executes change terminal date/time.
- E** (Uppercase) Exits to Dictionary-IV copyright screen.
- e** (Lowercase) Exits to the current menu.
- F** (Uppercase) Executes view prompt (view, link, or format); with the screen, link, or format name executes database maintenance on the specified screen, link, or format.
- f** (Lowercase) Executes screen prompt (screen, link, or format); with the screen, link, or format name executes database maintenance on the specified screen, link, or format.
- M** (Uppercase) Executes the specified Dictionary-IV menu.
- P** (Uppercase) Executes the specified Thoroughbred Basic program or compiled script.
- p** (Lowercase) Executes the specified Thoroughbred Basic program or compiled script, but drops all Public Programs.
- Q** (Uppercase) Run Thoroughbred Query-IV; with the query name print or display a specified query or range of queries.
- R** (Uppercase) Run Thoroughbred Report-IV; with the report name print or display a specified report or range of reports.
- S** (Uppercase) Executes System Security utility.
- T** (Uppercase) Executes Terminal Configurator utility.

Action

Type from 1 to 8 alphanumeric characters for the name of a program, Class, or definition to be accessed with this selection. Press **Enter**. This field is dependent upon the Type field and may not be required.

Type	Action	Description
P, p	program	Program or compiled script name
C, c	Class	CONNECT Class: METHOD MENU HELP SCREEN VIEW REPORT QUERY
M	menu	Dictionary-IV menu name
F, E	name	Format, Screen, View, or Link name for database Maintenance Thoroughbred Report-IV report name Thoroughbred Query-IV query name

This field is required for the following types: M, P, and p.

It may be used with the following types: F (multi-record maintenance for a specified view, link, or format), f (single-record maintenance for a specified screen, link, or format), Q (to print or display a specified query or range of queries), and R (to print or display a specified report or range of reports).

Object

When a menu selection executes a CONNECT (types C or c), the Object name is used to identify the name of the menu, help, screen, view, report, or query for the CONNECT.

When a menu selection executes a program (types P or p), the Object name is used to specify a Screen definition that will be processed before the program executes. All fields in the screen are collected and the resulting data passed to the program to be executed.

Pass Value (PV)

Specifies a variable to pass to a program.

Y Prints a single definition or a range of definitions.

N Displays a single definition or a range of definitions.

printer-id Prints a report or query to the designated printer.

If you select **Y** with a type **Q** and specific Query name(s), the system prints the specified Query definition or range of definitions. If you select **N** and specific Query name(s), the system displays the specified query definition or range of definitions.

If you select **Y** with a type **R** and specific report name(s), the system prints the specified report definition or range of definitions. If you select **N** and specific report name(s), the system displays the specified report definition or range of definitions.

The printer-id will print a single report (query) or a range of (queries) to the designated printer.

Any 2-character value entered in this field is passed to the Script-IV variable MENU-PARMS. For more information, see the Script-IV Language Reference.

Help

Specifies an optional help module to be displayed when the selection code is entered followed by pressing **F6** during menu processing. You may use an existing help module or create the help using standard help editing features.

To create help, type from 1 to 6 alphanumeric characters for the module to be displayed and press **Enter**. The Library in which the help module is located will be the same as that for the menu. Any help created in the menu can also be accessed through Help definition maintenance.

Press **F1** to enter or edit help.

You may then go to Help definition to change these default settings. For more information, see Help definition in this document. This field is optional.

Password (Pwd)

Type from 1 to 3 alphanumeric characters for the selection password and press **Enter**.

If system security is active and a menu password is specified, the password is required to execute a selection.

Terminal List (TL)

Press **Enter** to access. Use this field to allow access to or restrict access from the specified terminals. The syntax is the same as Link definition. For more information, see Link definition.

0, term-code [,term-code]...

0 Allows access to the specified terminal codes.

term-code Type the 2 alphanumeric character terminal codes for the terminals that can access this selection.

1,term-code [,term-code]...

1 Denies access to the specified terminal codes.

term-code Type the 2 alphanumeric character terminal codes for the terminals that cannot access this selection.

If this is left blank all terminals have access.

Examples:

0,T0, T3
Allows access for terminals T0 and T3.

1, T1
Denies access for terminal T1.

Operator List (OL)

Press **Enter** to access. Use this field to allow access to or restrict access from the specified operators. The syntax is the same as Link definition. For more information, see Link definition.

0, oper-code [,oper-code]...

0 Allows access to the specified operator codes.
oper-code Type up to 3 alphanumeric characters for the codes of the operators that can access this selection.

1,oper-code [,oper-code]...

1 Denies access to the specified operator codes.
oper-code Type up to 3 alphanumeric characters for the codes of the operators that cannot access this selection.

If this is left blank all operators have access.

Examples:

0,JBT, NRS
Allows access for operators JBT and NRS.

1, JMG
Denies access for operator JMG.

Menu Exit Message (ME)

Press **Enter** to access. Type a special prompt or message to be displayed after leaving the menu and before the menu selection is initiated. You may enter a message in this field or specify a message from the Message definition list.

Message Dictionary

**dictionary;type,number[,disp-Mode
[,clear[, (col,row)]]]**

or

@(col,row[,disp-mode])msg

dictionary is the name of the Dictionary-IV Message Dictionary.

type select one of the following message types:
P prompt/constant.
N non input (with suffix and **Enter**).
n non-input (without suffix or **Enter**).
x non-input (without suffix and wait for **Enter**).

number is the number of the message in the dictionary.

disp-mode is one of the following:
blank foreground.
B background.
F foreground.
R reverse video foreground.
r reverse video background.

Defaults to **R**.

clear enter one of the following:

A	clear line before and after.
B	clear line before.
C	clear line after.
D	clear message area after.
E	clear screen before and after.
F	clear screen before.
G	clear screen after.
X or blank	do not clear before or after. Blank defaults to the code from the dictionary definition.

col is the starting column position of the display. The default is the dictionary definition position.

row is the starting row position of the display. The default is the dictionary definition position.

msg is the message to display. It may be from 1 to 132 characters and may display on two lines (depending on length and location).

Exit messages are not processed for menu selection type "M" (the selection of another Dictionary-IV menu).

Examples:

IDMSG;P, 10
 Displays the prompt/constant message number 10 from the dictionary.

IDMSG;N,12,R,A,(20,2)
 Displays the non-input message number 12 from the IDMSG dictionary. The message is displayed in reverse video at column 20, row 2 and the message area is cleared before and after the message is displayed.

Open Files (OF)

Press **Enter** to access. This field is mainly used to interface with 3GL applications. For developers who wish to use menu selection to run an application program, this option automatically opens files for the application program. In addition, this item can automatically open a printer and the user terminal.

List the file names that will open when this selection is made. This cannot be used with Script-IV.

channel , file-name [; channel , file-name] . . .

file-name is the 1 to 8 alphanumeric character name of the file to be opened.
 The following two names can be used:
 'TERMINAL' opens the user terminal.
 'PRINTER' prompts for the printer if and opens it.

If any file cannot be opened a message is displayed and the system returns to the menu.

Example:

```
1,CCSMS;2,CINVI;6,'PRINTER';3,'TERMINAL'; 8PRMSTR
```

Channel 1 opens to CCSMS, channel 2 opens to CINVI, channel 6 opens to the printer, channel 3 opens to the user terminal, and channel 8 opens to PRMSTR.

Conflict Test (CT)

Press **Enter** to access. Conflict processing insures that once a file is opened for maintenance, another operator cannot open it. This is done by setting a flag.

This statement tests conflict flags for a condition to determine whether the menu selection is to be executed. If any flags indicate a conflict, a conflict message displays and the selection is denied.

```
table:flag rel-oper val[log-oper flag rel-oper val...]
```

table is the conflict table name. The table must be created using the Multi-Tasking Information utility before it can be used. For more information, see Multi-Tasking Information in the Dictionary-IV Administrator Guide.

flag is the type of flag (alphanumeric or numeric) and the flag number in the table. Flags are specified in the format:

type.number

type select one of the following:

A alphanumeric.

B numeric.

number is the flag number from 1 to 120.

rel-oper is the relational operator. For more information, see Common Syntax Elements in the Dictionary-IV User Guide.

val is a constant, flag value, or expression that results in a numeric value from 0 to 255 or a 1 alphanumeric character value to be assigned to the flag.

log-oper is the logical operator used to specify multiple tests. For more information, see Common Syntax Elements in the Dictionary-IV User Guide.

Example:

```
PRMT1:A.1=$00$ AND N.1 = 0
```

In the conflict table PRMT1, if alphanumeric flag A.1 contains the NULL character (\$00\$) and numeric flag N.1 is equal to 0, the menu selection is allowed to execute.

Conflict Set (CS)

Press **Enter** to access. Conflict processing insures that once a file is opened for maintenance, another operator cannot open it. This is done by setting a flag.

The set flags statement is used to set conflict flags before the selection is executed.

table:flag=val[,flag=val...]

table is the conflict table name. The table must be created using the Multi-Tasking Information utility before it can be used. For more information, see Multi-Tasking Information in the Dictionary-IV Administrator Guide.

flag is the type of flag (alphanumeric or numeric) and the flag number in the table. Flags are specified in the format:

number.type

type select one of the following:

A alphanumeric.

B numeric.

number is the flag number from 1 to 120.

val is a constant, flag value, or expression that results in a numeric value from 0 to 255 or a 1 alphanumeric character value to be assigned to the flag.

Example:

```
PRMT1:A.1 = "A",N.1 = N.1 +1
```

In conflict table PRMT1, alphanumeric flag A.1 is set to "A" and numeric flag N.1 is incremented by 1.

Conflict Reset (CR)

Press **Enter** to access. Conflict processing insures that once a file is opened for maintenance, another operator cannot open it. This is done by setting a flag.

The reset flags statement is used to set conflict flags after the selection has been executed and when the user returns to the menu.

table:flag=val[,flag=val...]

table is the conflict table name. The table must be created using the Multi-Tasking Information utility before it can be used. For more information, see Multi-Tasking Information in the Dictionary-IV Administrator Guide.

flag is the type of flag (alphanumeric or numeric) and the flag number in the table. Flags are specified in the format:

type.number

type select one of the following:

A alphanumeric.

N numeric.

number is the flag number from 1 to 120.

val is a constant, flag value, or expression that results in a numeric value from 0 to 255 or a 1 alphanumeric character value to be assigned to the flag.

Example:

```
PRMT1:A.1 = "A",N.1 = N.1 + 1
```

In conflict table PRMT1, alphanumeric flag A.1 is set to "A" and numeric flag N.1 is incremented by 1.

Creating the Screen Interface (If You Use IDMENUIN)

You must create a user interface screen for menu processing.

The name of the screen must be the same as the screen name in the Menu definition header.

At the link/format field, the system displays the following message at the top of the screen:

For a Menu Screen, use IDMENUIN as the Link/Format.

You may type IDMENUIN and press **Enter** or define your own link/format. For more information, see "Creating the Menu format." Also see Format definition.

You may create a standard or window screen.

In your Screen definition list the menu selections and descriptions. You must define one data field using the data name from the format.

IDMENUIN creates a data field named MENU-SELECTION. It can be placed anywhere on the screen and represents the area in which the user enters the menu selection.

For more information on screen creation, see Screen definition in this document.

Creating the Menu Format (If You Do Not Use IDMENUIN)

Create a format with one Data Name with a length equal to the largest selection code. This Data Name will be used in the menu screen for menu selection.

If you do not define a format use IDMENUIN (a one Data Name format with a length of 9). For more information about IDMENUIN, see "Creating the screen Interface" in this document.

Modifying a Menu

A Menu definition can be changed. Selections can be added, deleted, or modified, but you should update the menu screen accordingly. If you add a selection code, which exceeds the length of the Data Name defined in the menu format, remember to change the Data Name length in the format.

To edit selection specifications position the cursor on the selection code and press **F1**. The system now positions the cursor at the **Type** field. Move through all of the fields or use **F4** to return to the selection code list. Press **F4** to save and exit the definition.

Accessing a Menu

A menu can be accessed from any Dictionary-IV menu by typing a semi-colon followed by the menu name at the selection prompt and pressing **Enter**. For example, type **;TPMENU** at the selection prompt and press **Enter** to display the menu TPMENU.

A menu can also be tied to an operator code so that after login operator is automatically brought to the menu. For more see Operator Information in the Dictionary-IV Administrator Guide.

The password (if one was specified for the menu and system security is active) is required before the menu screen is displayed. If it is not given, the operator is returned to the previous menu. If the correct password is entered, the screen is displayed and the menu accessed.

The following is a summary chart of Type/Action/Object Name/Pass Value and the actions they execute:

Type	Action	Object Name	PVal	Executes
P	program			Executes specified Basic Program or compiled script.
p	program			Executes specified Basic Program or compiled script, but drop ADDR'd public program.
M	menu			Execute specified Dictionary-IV menu.
A				Database Maintenance Prompt (Screen or View).
F				View Prompt (View, Link, or Format).
F	name			Database Maintenance or specified Screen, Link, or Format.
f				Screen Prompt (Screen, Link, or Format).
f	name			Database Maintenance on specified Screen, Link, or Format.
E				Exit Dictionary-IV.
Type	Action	Object Name	PVal	Executes
e				Exit current menu.
D				Change System Date/Time.
d				Change Terminal Date/Time.
S				System Security Utility.
T				Terminal Configurator Utility.
R	name		Y/N	Y - prints specified Thoroughbred Report-IV report. N - displays specified Thoroughbred Report-IV report.
R	name	name	Y/N	Y - prints range of Thoroughbred Report-IV reports. N - prints range of Thoroughbred Report-IV reports.
Q				Runs Thoroughbred Query-IV or TQ.
Q	name		Y/N	Y - prints specified Thoroughbred Query-IV query. N - displays specified Thoroughbred Query-IV query.
Q	name	name	Y/N	Y - prints range of Thoroughbred Query-IV queries. N - displays range of Thoroughbred Query-IV queries.
C	Class	name		Execute specified CONNECT Class: MENU, HELP, METHOD, SCREEN, VIEW, REPORT, and QUERY.
c	Class	name		Execute specified CONNECT, first create an 80 x 24 window.

MESSAGES

Dictionary-IV provides a message Dictionary where messages are defined and stored. Using a message Dictionary allows you to avoid placing messages in a script or Format definition, which simplifies customization, language conversion, and maintenance.

Defining the message (content, display, position, etc.) in the dictionary saves development time and allows you to maintain consistency throughout a software application.

Messages are then referenced by the dictionary name, message type, and message number. These messages are used in Format definitions, menu definitions, reports, and scripts. The message display defaults can be overridden from any of these points.

If you are operating in a Multi-Language environment see Multi- Language in the Dictionary-IV Administrator Guide.

Some of the features of a message dictionary are:

- Operator input and response for the message can be controlled and validated.
- Automatic on-line help can be defined for all message types except prompt/constant. If help is defined for a message, pressing **F6** when this message is displayed brings up the help information.
- Application specific messages can be defined by using a substitution value in a message, which allows a variable parameter to be used when a message is displayed.
- Multiple message dictionaries can be referenced from one application.
- Special display modes are available, including a select (scroll type) message.
- You can override the dictionary specifications without altering the stored definition.
- Translation values (useful for foreign language translation) can be specified for messages requiring operator input.

The following diagram shows the structure of the Dictionary-IV message Class:

Multiple Message Dictionaries in the System Dictionary

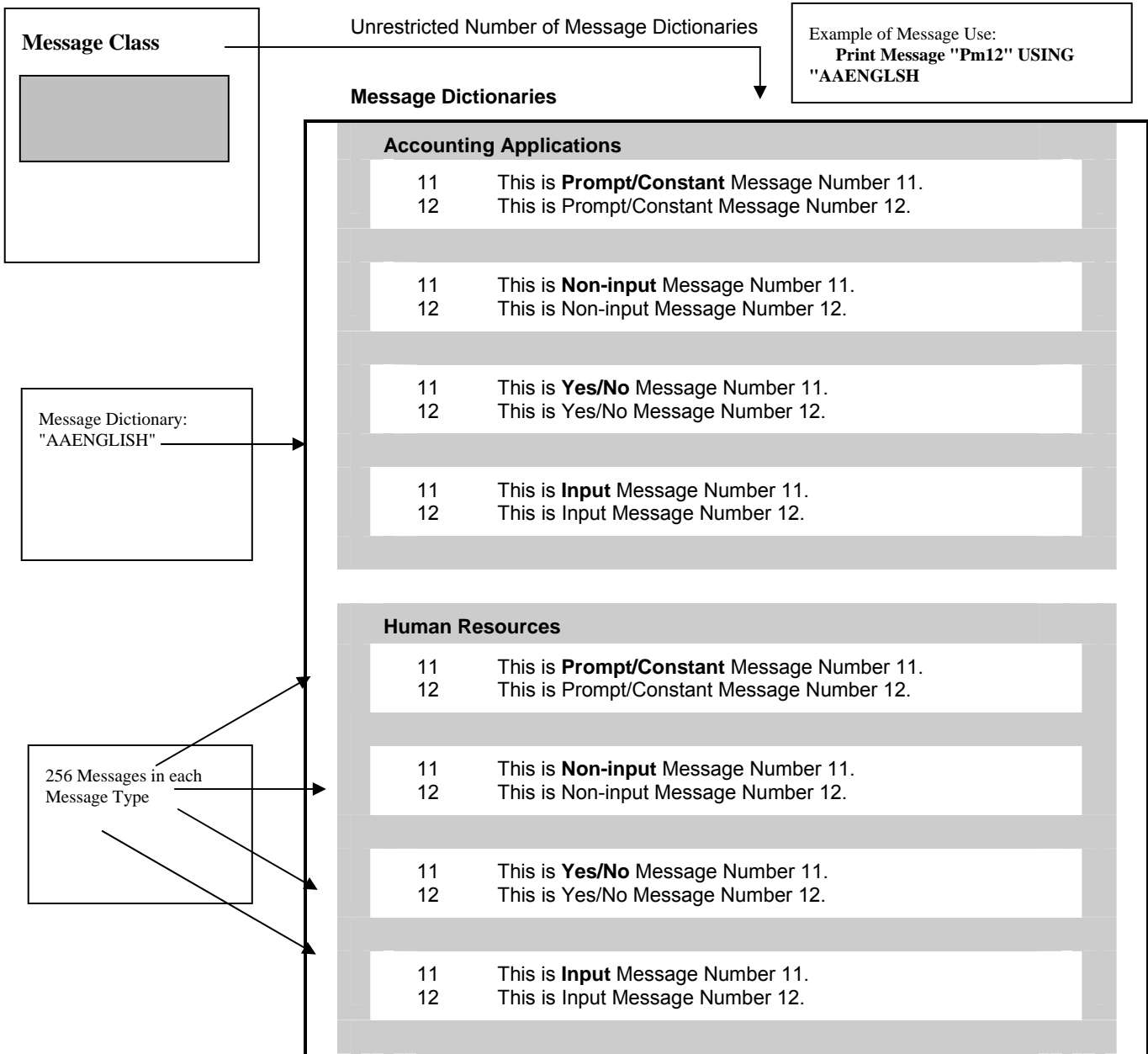

Types of Messages

There are four types of messages: Prompt/Constant, Non-input, Yes/No, and Input.

The type of message determines the degree of operator input allowed. A predefined suffix is automatically appended to certain message types. For more information, see Message Dictionary Suffixes in this document.

Prompt/Constant

This message type is the simplest. You can specify the position, display mode, line clearing, and message content. It does not allow user response. On-line help is not available.

Message numbers 1 through 4 are used by Dictionary-IV as suffixes for other message processing. The naming of these messages cannot be altered.

Non-input

This message type is the same as the prompt/constant messages. Differences are that you are allowed to specify help for the message, predefined suffix is automatically appended to the message, and the user is required to press **Enter** to continue. User responses allowed from this message type are: **Enter**, **F4**, and **F6**.

Yes/No

This message requires the user to answer **Yes** or **No** in response to the message. A predefined suffix is automatically appended to the message. User responses allowed are: **F4**, **F6** and the characters defined in Message Number 1 Prompt/Constant. This is what is used to validate input of a Y/N message.

Input Message

This message allows you to specify the following input parameters: input length, input window length, fixed or variable length input, mandatory or optional input, numeric type, padding type, date type, and valid entries. A predefined suffix is automatically appended to the message. User responses are restricted by the input specifications.

Select message

Select messages are a special type of input message. They can be specified to display multiple selections and allow the operator to scroll through the options, highlighting each selection. The operator can press **Enter** to make a selection or press the selection character. The input message suffix is not appended to select messages. For more information, see Select messages in the Dictionary-IV User Guide.

Selection

Select **1-Edit** from the Dictionary-IV Development Menu or press **F1** from any Dictionary-IV menu. The system displays the Class pop-up menu:

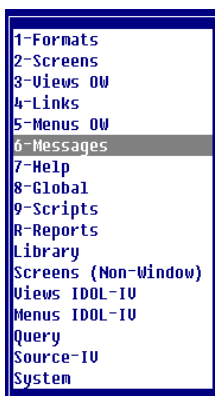

Select **6-Messages**.

Message View

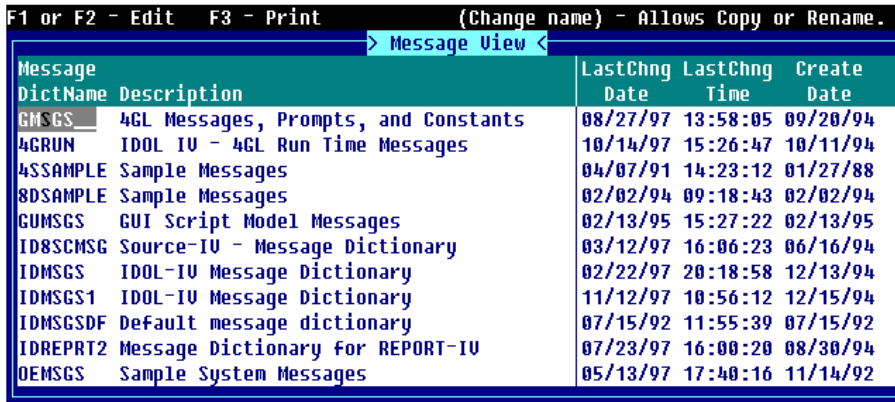

The screenshot shows a window titled "Message View" with a menu bar containing "F1 or F2 - Edit", "F3 - Print", and "(Change name) - Allows Copy or Rename.". The window displays a table with the following columns: Message, DictName, Description, LastChng Date, LastChng Time, and Create Date. The data rows are as follows:

Message	DictName	Description	LastChng Date	LastChng Time	Create Date
GMSG	4GL	4GL Messages, Prompts, and Constants	08/27/97	13:58:05	09/20/94
4GRUN	IDOL IV	IDOL IV - 4GL Run Time Messages	10/14/97	15:26:47	10/11/94
4SSAMPLE		Sample Messages	04/07/91	14:23:12	01/27/88
8DSAMPLE		Sample Messages	02/02/94	09:18:43	02/02/94
GUMSG	GUI	Script Model Messages	02/13/95	15:27:22	02/13/95
ID8SCMSG	Source-IV	Message Dictionary	03/12/97	16:06:23	06/16/94
IDMSG	IDOL-IV	Message Dictionary	02/22/97	20:18:58	12/13/94
IDMSG1	IDOL-IV	Message Dictionary	11/12/97	10:56:12	12/15/94
IDMSGDF		Default message dictionary	07/15/92	11:55:39	07/15/92
IDREPR2		Message Dictionary for REPORT-IV	07/23/97	16:00:20	08/30/94
OEMSG		Sample System Messages	05/13/97	17:40:16	11/14/92

Components of Message View

The Message definition is composed of two parts: the header information and Message definition specifications.

Message View Header Information

The message dictionary header information provides the specifications for the dictionary. The name and description are used to identify message dictionary within the System Dictionary and allow you to access and reference the dictionary in format and menu definitions, and in scripts. The list type is used to specify the type of message and is used to reference the message.

Enter the following information:

Message Dictionary Name

Type from 3 to 8 alphanumeric characters for the name of this message and press **Enter**. This field is mandatory.

Characters one and two are the Library name. Characters three through eight are the message name.

For more information, see Class definition in this document, which provides a file naming convention you may implement.

Description

Type up to 30 alphanumeric characters for the description of message dictionary and press **Enter**. This field is optional.

Last Change Date

Displays the date of the last change to the selected Message.

Last Change Time

Displays the time of the last change to the selected Message.

Create Date

Displays the date of creation of the selected Message.

Editing Messages

Press **F1** to edit messages and the system displays the following:

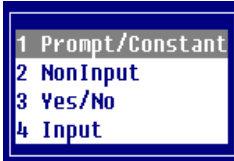

Select one of the following:

1 Prompt/Constant

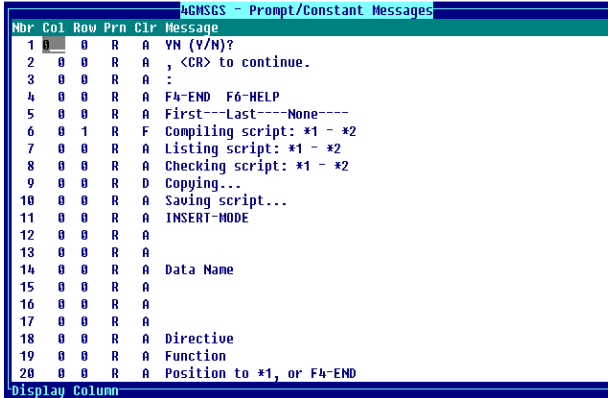

2 NonInput

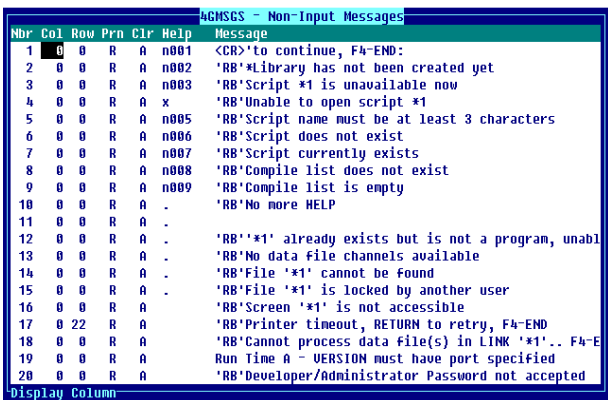

3 Yes/No

4GMSGC - Yes/No Messages						
Nbr	Col	Row	Prn	Clr	Help	Message
1	0	22	R	A	y01	Is the displayed information correct
2	0	0	R	A	y02	Are you sure you want to delete
3	0	0	R	A	y03	Save script modifications
4	0	0	R	A	y04	Do you want to continue
5	0	0	R	A	.	Do you want to abort processing
6	0	22	R	A	y06	Do you want to compile from *1 generated *2
7	0	0	R	A	y07	Do you want to save and compile
8	0	0	R	A		Terminate
9	0	22	R	A	y09	Do you want a printed copy
10	0	0	R	A	y10	Verify each replace
11	0	0	R	A	y11	Replace with '*1'
12	0	0	R	A	y12	'RB'Program *1 already exists, Replace
13	0	0	R	A	y13	'RB'Do you want to erase program '*1'

Display Column

4 Input

4GMSGC - Input Messages													
Nbr	Col	Row	Prn	Clr	Help	P	D	N	Input	Win	E	U	Message
						T	T	Length	Len	T	U		
1	0	0	R	A	i001	0	0	8	8	0			Enter new name
2	0	0	R	A	i002	0	0	8	8	0			Enter copy to name
3	0	0	R	A		0	0	1	1	0			
4	0	0	R	A	i004	0	0	20	20	0			GOTO - Enter procedure name
5	0	0	R	A	.	0	0	1	1	0	X		(S)earch or (R)eplace
6	0	0	R	A	i006	0	0	40	40	0			Search for
7	0	0	R	A	i007	0	0	40	40	0			Replace with
8	0	0	S	A		0	0	1	1	0			
9	0	0	R	A		0	0	5	5	0			
10	0	0	R	A		0	0	3	3	0			
11	0	0	R	A		0	0	2	2	0			
12	0	0	R	A		0	0	8	8	0			
13	0	0	S	A	.	0	0	1	1	0			
14	0	0	S	A		0	0	1	1	1			
15	0	1	S	A	i015	0	0	1	1	0	X		1-Fmt 2-Scrn 3-View 4-Link
16	0	0	R	A		0	0	3	0	0			Retype Developer/Administrator
17	0	0	R	A		0	0	0	0	0			No compile errors encountered
18	0	22	S	A	.	0	0	1	1	0	X		INCLUDE Command Statements: [B
19	0	22	S	A	.	0	0	1	1	0	X		1-Primary 2-Cont 3-Overlay

Display Column

Message Attributes

The Message definition attributes display the specifications and content of the message. Additional attributes are available for Input messages. Default values are displayed in these fields when **F1** is used to create a message.

The existing messages are listed in numeric sequence on the bottom half of the screen.

The following are available in Message definition attributes. Look for the field names specific to your type of message:

Key	Description
F1	Creates a new message. Press F1 and the system displays the next available message number. You may begin defining this message.
F4	Make corrections, exit without saving, or exit and save.
F5	Prints. Press F5 and the system prompts for the printer name. Make your selection and the message list prints.
F6	Displays on-line help.
F10	Goes to a specific message number in the list. The system prompts for the message number. Type the number and press Enter . The system displays that Message definition.
Page Up	To move up the message list one page at a time.
Page Down	To move down the message list one page at a time.

You may enter the following information (depending on the type of message you are creating):

Message Number (Nbr)

Type a number from 1 to 255 to edit an existing message number. Press **F1** to add a new message. The system displays the next available message number.

Each message is assigned a number in ascending order. When calling a message you will reference the message type and number. This field is mandatory.

Column (Col)

Type a number from 0 to 79 for the column where this message will start and press **Enter**. The default is **0**. This field is mandatory.

Row

Type a number from 0 to 23 for the row where this message will start and press **Enter**. Row 99 specifies the status line. The default is **0**. This field is mandatory.

Print Mode (Prn)

Select one of the following for the display print mode:

- (blank) Foreground.
- B Background.
- F Foreground.
- R Reverse video foreground.
- r Reverse video background.
- S Scrolling Select Message; selections in reverse video background.
- s Scrolling Select Message; reverse video background.

The default is **R**.

Clear Mode (Clr)

This is an optional code that sets the clearing option for the message. Depending upon the clear code, one line or the entire screen can be cleared before and/or after the message is displayed.

Select one of the following:

Clear AREA Before and/or After Message is Displayed?	AREA			
	Line	Msg	Screen	Do not clear
Before/After	A		E	X or (blank)
Before	B		F	
After	C	D	G	

This code specifies the clearing option for the message.

- The default is **A** for input, non-input, and yes/no messages.
- The default is **B** for prompt/constant messages.

Help

Type from 1 to 6 alphanumeric characters for the help module and press **Enter**. This is the text to be displayed when you press **F6** for the item.

When a help request is processed, Dictionary-IV searches the Library for the help module in a non-window format. If the help is not found, then it searches the Library for the help module in a window format.

The Library where help is located is the same as the message you're defining.

You may specify a new or existing module. Press **F1** to edit help text. Press **Enter** or **Down Arrow** to enter a help module name in the field without invoking the editor.

In non-window help, before entering text, make sure the help window width is the appropriate size.

To modify the width use **F5** Change Help Window Width at the item.

This field is not available for prompt/constant messages.

Pad Type (PT)

This field is only available for input messages. Determines the leading and trailing characters to be used. Padding is independent of whether a field is numeric or alphanumeric.

The padding can be either spaces or zeros placed before or after the input.

Select one of the following for the input padding type:

- 0** Left justify and pad with trailing spaces.
- 1** Right justify and pad with leading spaces.
- 2** Left justify and pad with trailing zeros.
- 3** Right justify and pad with leading zeros.

The default is **0**. For more information, see Formats in this document.

Date Type (DT)

This field is only available for input messages. The date type defines the format of a date; where DD = day, MM = month, YY = year, and CC = century. For more information see Date Type (DT) in Formats.

Select one of the following:

- 0** Not a date.
- 1** MMDDYY Automatically sets the Length field to 6 and makes this a fixed length field.
- 2** YYMMDD Automatically sets the Length field to 6 and makes this a fixed length field.
- 3** DDMMYY Automatically sets the Length field to 6 and makes this a fixed length field.
- 4** YYDDD (Julian Calendar) Automatically sets the Length field to 5 and makes this a fixed length field.
- 5** SQL Automatically sets the Length field to 6 and makes this a fixed length field. For more information, see Valid Entries.
- 6 & 7** Not supported in messages.
- 8** MMDDYYYY Date type 8 stores Thoroughbred Basic SQL data as a number in your data files. This eliminates the problems caused by binary storage found with Date Type 5. Date type 8 is stored as a string.

Date type 5 is stored as a 6 byte binary field, but the definition length is 6 and the numeric type is 0. This stores date and time. To store just the date, set the length to 4 and the numeric type to 0. When date type 5 is stored in 4 bytes, the result is an Informix compatible SQL date.

To convert from:	Use:
A numeric SQL date to a 6 byte binary format	PRECISION 4; DATE\$=BIN(INT(ND*10000),6)
A numeric SQL date to a 4 byte binary format	DATE\$=BIN(ND-693597,4)
A 6 byte binary field to a numeric SQL date	PRECISION 4; ND=DEC(DATE\$)/10000
A 4 byte binary field to a numeric SQL date	ND=DEC(DATE\$)+693597

If you previously selected a padding type for a telephone number, social security number, or text field, the system automatically enters the default value of **0** in these fields.

During file maintenance the system automatically tests for input of valid date values. If the type is mandatory and you press the **Enter** key the system displays the current date in the selected format.

For more information, see Formats in this document.

Numeric Type (NT)

This field is only available for Input messages. Specifies the storage method and the types of numbers that are accepted as valid input.

Select one of the following for the input numeric type:

- 0** Fixed point positive/negative
- 1** Fixed point positive
- 2** Fixed point negative
- 3** Binary positive/negative
- 4** Binary positive
- 5** Binary negative
- 6** Packed positive/negative
- 7** Informix
- 8** IEEE single precision
- 9** IEEE double precision
- A** BCD signed
- B** BCD unsigned
- C** BCD no sign
- D** ASCII sign masked
- E** ASCII leading byte sign
- F** ASCII trailing byte sign

The default is **0**. For more information, see *Formats* in this document.

Input Length

This field is only available for Input messages. It specifies the maximum size of the message input and defines the input as alphanumeric or numeric.

The same rules apply to message input length as Data Name (except repeating fields are not allowed). For more information, see *Formats* in this document.

Window Length (Win Len)

This field is only available for Input messages. It specifies the message input window length. This is the length of the input as displayed on the screen.

It does not limit the actual length of the input. If you reach the end of the window, the input will scroll.

This field is similar to the `/FIELD(n)=` option in screen formulas.

Entry Type (ET)

This field is only available for Input messages. Specifies whether input is optional or mandatory and of variable or fixed length.

Select one of the following for the input entry type:

- 0** input optional, variable length
- 1** input optional, fixed length
- 2** input required, variable length
- 3** input required, fixed length

The default is 0. For more information, see Formats in this document.

Valid Values

This field is only available for input messages. This specifies values that can be accepted as valid for entry. With the exception of select messages, message valid entries follow the same rules as valid entries in the format. Use the following syntax:

Valid Values: List

0, val-1[, val-2...][:trans-val-1,trans-val-2...]

For a select message you must specify a list of valid values (valid values type 0).

The valid values list syntax for select messages allows you to select multiple sets of valid entries (and translation values) that correspond with the selections in the select message.

For more information, see Select message. Also see the Valid Values section in Formats.

Valid Values: Range

1, lo-val-1, hi-val-1[; lo-val-2, hi-val-2...]

Valid Values: File Lookup

2, lookup-link, read-opt[, "prefix"]

Valid Values: Text Field Window

Text fields (type 3) are not valid for messages.

Message

Type the message that is to display on the screen. The length can range from 1 to 80 characters. Messages cannot be deleted. They can be changed.

You should not modify the default messages, but add to the list.

You can place the following codes in front of the message:

'RB' To beep (Ring Bell) when the message displays.

'CI' To clear the type-ahead buffer (Clear Input) when message displays.

On color terminals the RB and rb are used to control the colors.

Message Type	Message Color	How to Display
Critical Message	White on Red	'rb' precedes text
Warning Message	Black on Yellow	'RB' precedes text
Information Message	Black on White	Default - do not use 'rb' or 'RB'

Examples:

Value entered is not allowed.
Displays the message typed.

'RB' Do not enter zero!
Rings the bell and displays the message typed. The black text displays on a yellow background.

'CI' Are you sure you want to delete?
Clears the input and displays the message typed.

The following fields apply only to Input messages.

Message Maintenance

The size of the message dictionary affects script memory usage, but the number of message dictionaries specified in a script does not. Therefore, it may be better to define two or more smaller message dictionaries than to create one large message dictionary for a software application.

Message dictionary maintenance differs from standard definition maintenance in the way that specifications are saved. If you change specifications in standard definition maintenance, when you exit, you must verify whether or not you want to save the changes.

In message maintenance, changes are saved on a field-by-field basis. If you edit or change a message specification, such as the message text, the changes will be saved when you move to the next field. You can cancel the changes to a field by pressing **F4** at that field and before you move to the next field.

Create Messages

Type the message dictionary name and the optional description and press **Enter**.

Enter the type of message you wish to create, and the appropriate definition screen displays.

Press **F1** and the next available message number is displayed in the Msg# field; default values are shown in the specification fields and the cursor is positioned at the Col field (column).

Modify the default values as necessary and enter in the message text. The system adds the message to the dictionary and the fields clear to allow a new entry. The cursor returns to the message number field. The existing messages display in the bottom part of the screen with the new message last.

Modify Messages

Enter the message type that you wish to modify.

Enter the message number and the corresponding specifications are displayed. Use the standard editing keys to change the definition. Changing the message in the dictionary changes the message globally (wherever you specify the message dictionary, type, and number).

A message number cannot be deleted once a message is created for it, but the message number can be re-used by changing the definition. To keep track of unused messages, when a message number becomes available the developer should replace the message text with a comment such as:

Not Used
or
Available

Message Dictionary Suffixes

When creating a new message dictionary, four prompt/messages are automatically generated. These messages provide the suffixes for the Yes/No, Non-input, and Input message types.

They can be altered, but they still function in the same way. You should keep this in mind when creating messages, so that you do not repeat the suffix in your message.

YN (Y/N)?

Prompt/constant message #1 is used as a suffix for all Yes/No messages. The first part of the suffix 'YN' is not appended to the message but is used to validate message input. For the Y/N use in multiple languages, see Multiple Language in the Dictionary-IV Administrator Guide.

, RETURN to Continue

Prompt/constant message #2 is used as a suffix for all Non-input messages. An option is provided in scripts and formats to suppress this suffix.

:

Prompt/constant message #3 is used as a suffix for all Input messages, except blank messages (no text) and Select messages.

F4-End F6-Help

Prompt/constant message #4 is used as a suffix for all messages.

Select Messages

A special type of input message called a select message is used to display multiple selections through which the operator can scroll the cursor and make a selection.

For more information about the display and operation, see Select messages in the Dictionary-IV User Guide.

Select Message Definition

The following specifications must be used for a select message:

- Message list type 4 (Input messages).
- Print or Display Mode (Prnt field) of S or s.
 - S** Uses normal display mode for the message, with the current selection in background reverse video.
 - s** Uses background reverse video for the message, with the current selection in foreground reverse video.
- The Message Text field is used to specify the selections for the message.
- The Length field (entry length) must be 1.
- The Valid Entries field specifies selection values that correspond with the selections in the message text (see below).

Message Text

| Add | | Change | | Delete | | Rename |

Message Text

The Message Text field specifies the message and the beginning and end of each selection.

Use pipe characters (|) to delimit each selection and to mark the start and end of reverse video.

Spacing of text inside a selection is optional, and spacing between selections is optional.

Text can be placed before, after, or in between the selections. The selection bar does not highlight this text.

Valid Values

The Valid Values field specifies selection values that correspond position with the selections defined in the message text.

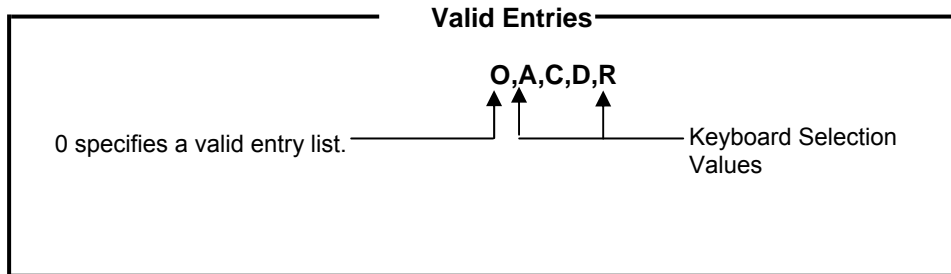

The valid entries must be preceded by a (0), which specifies a valid entries list (rather than a range or file lookup). Each entry should be separated by a comma.

A select message can be specified in a script using the INPUT MESSAGE command. When the user makes a selection, the corresponding value from the valid values list is returned to the script.

For more information, see the Script-IV Language Reference.

Translation Values

Translation values allow you to change the message text of input messages (including select messages) without having to change the scripts that use those messages.

This allows your messages to be independent of the script logic that processes the user response to the messages.

Translation values can also be used with any data name that is defined in a format. They are documented in formats under Valid. For example:

0,A,C,D,R:1,2,3,4

While Create, Modify, Erase, and New-name appear on the screen, the following translations take place.

Keyboard Selection Values:	Translates to:
Add	1
Change	2
Delete	3
Rename	4

For information on translation values in Multi-Language environments, see Multi-Language in the Dictionary-IV Administrator Guide.

Translation of a Sample Select Message

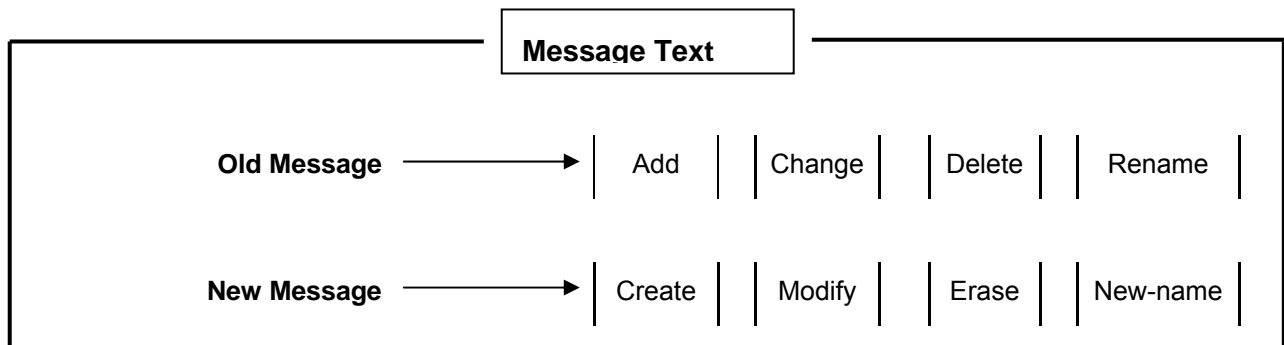
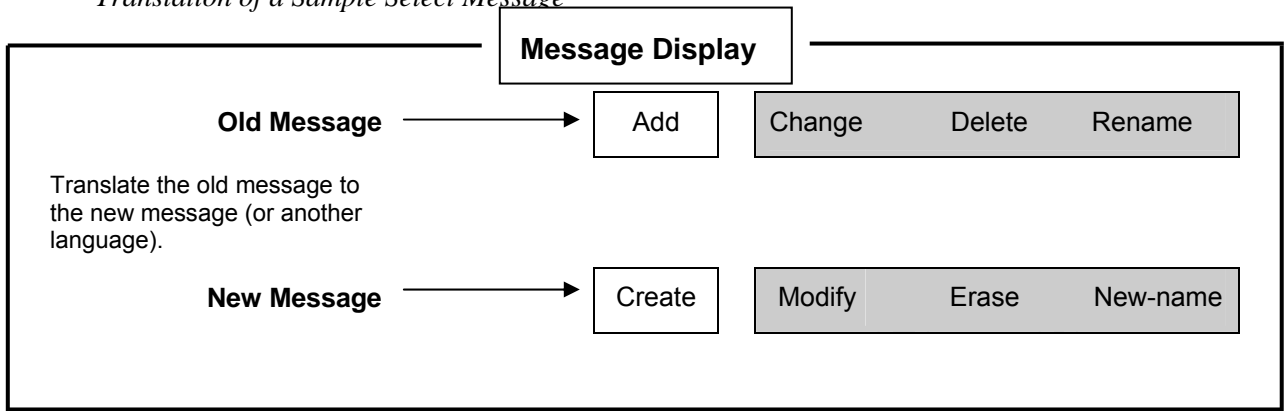

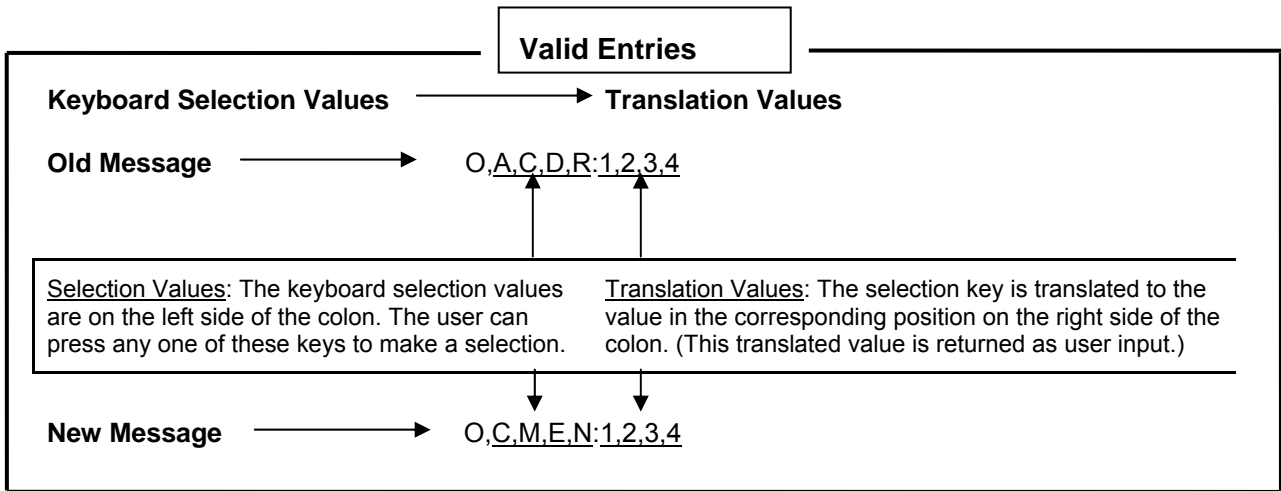

How Translation Values Provide Independence

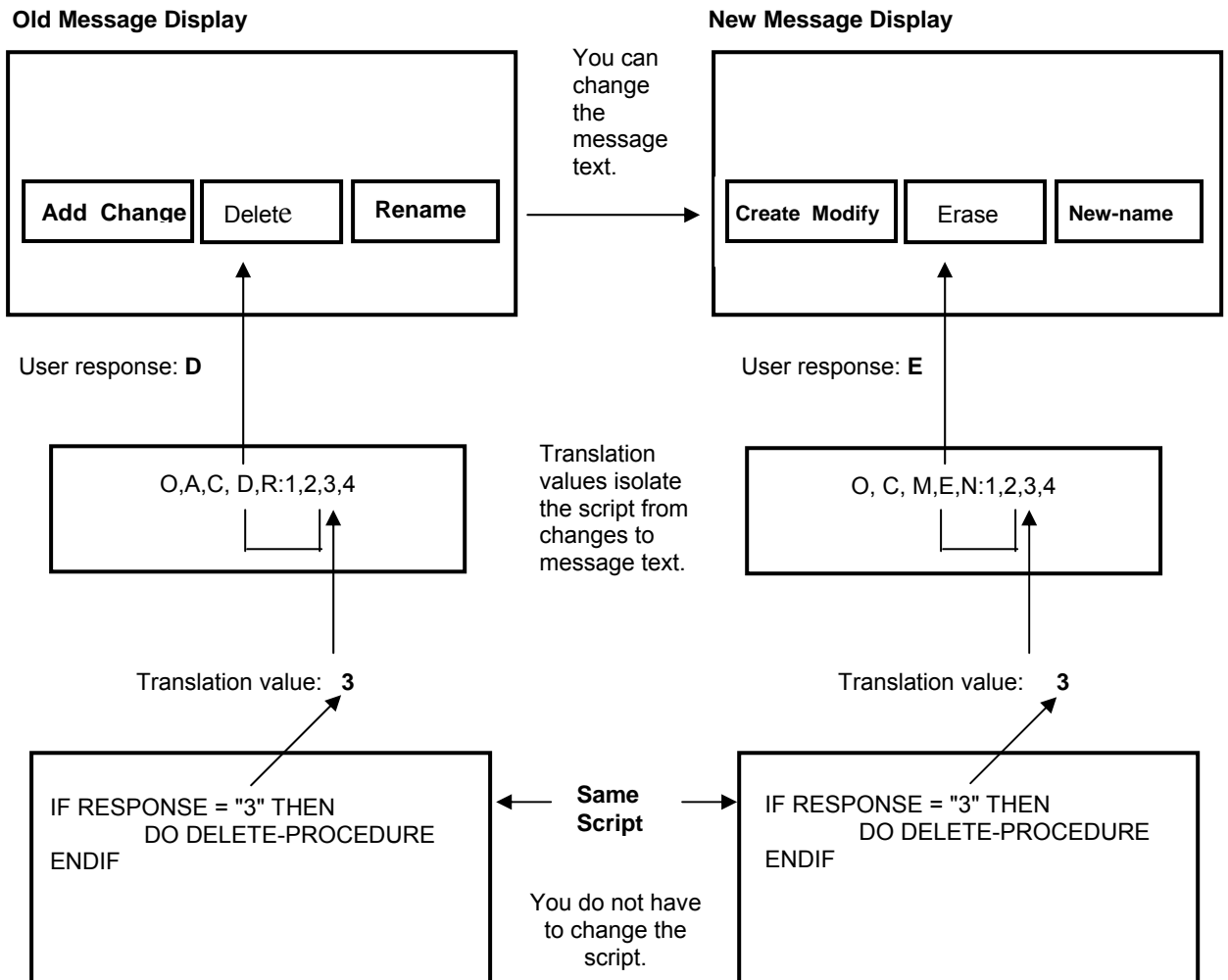

Multiple Selection Mapping

Multiple selection sets can be used in select messages to specify more than one keyboard selection value per displayed selection (more than one set of keyboard selection values).

For example, if one set of selection values are specified, the user can press one of three keys to make the same selection. Multiple selection sets are defined in the valid entries list.

Multiple selection mapping is an efficient method of handling the user responses to a message that has multiple selection sets. The mapping is an option defined in the valid entries list using translation values, which allows you to map, or translate, multiple sets of keyboard selection values to a single set of processed values.

Multiple selection mapping is illustrated in the following diagrams.

Example of Multiple Selection Mapping in a Select Message

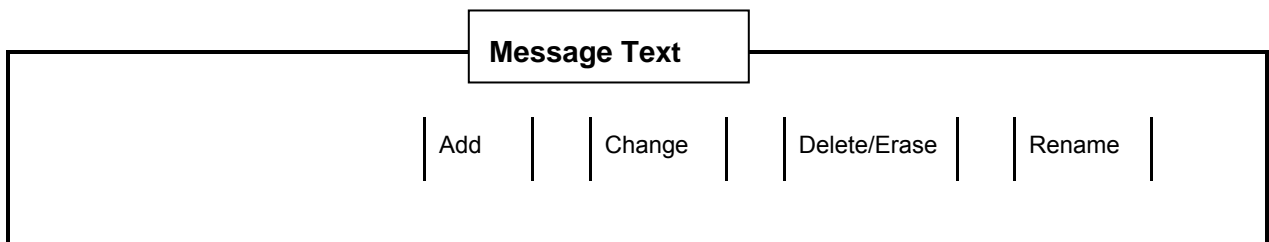
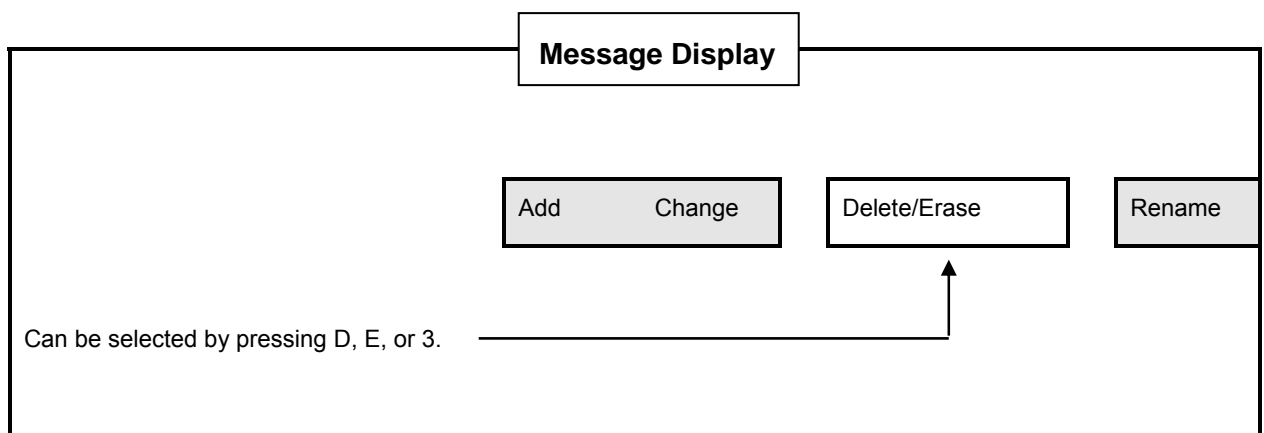

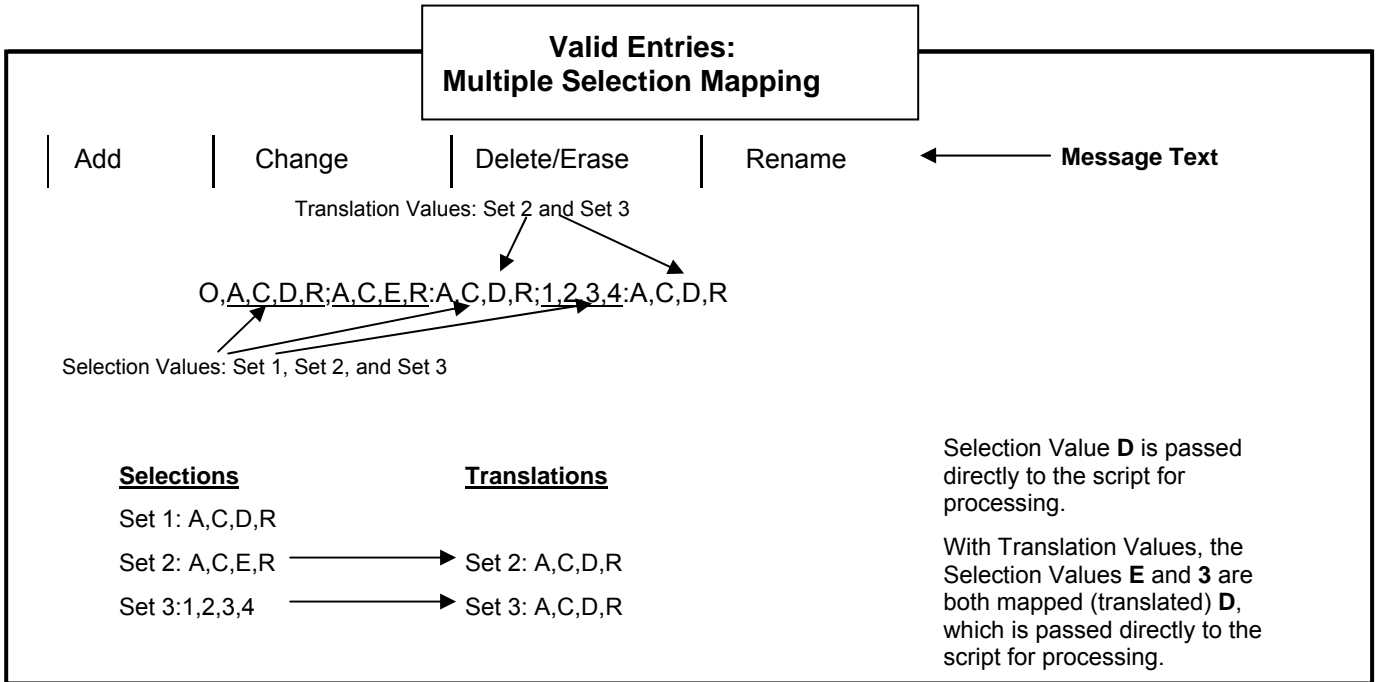
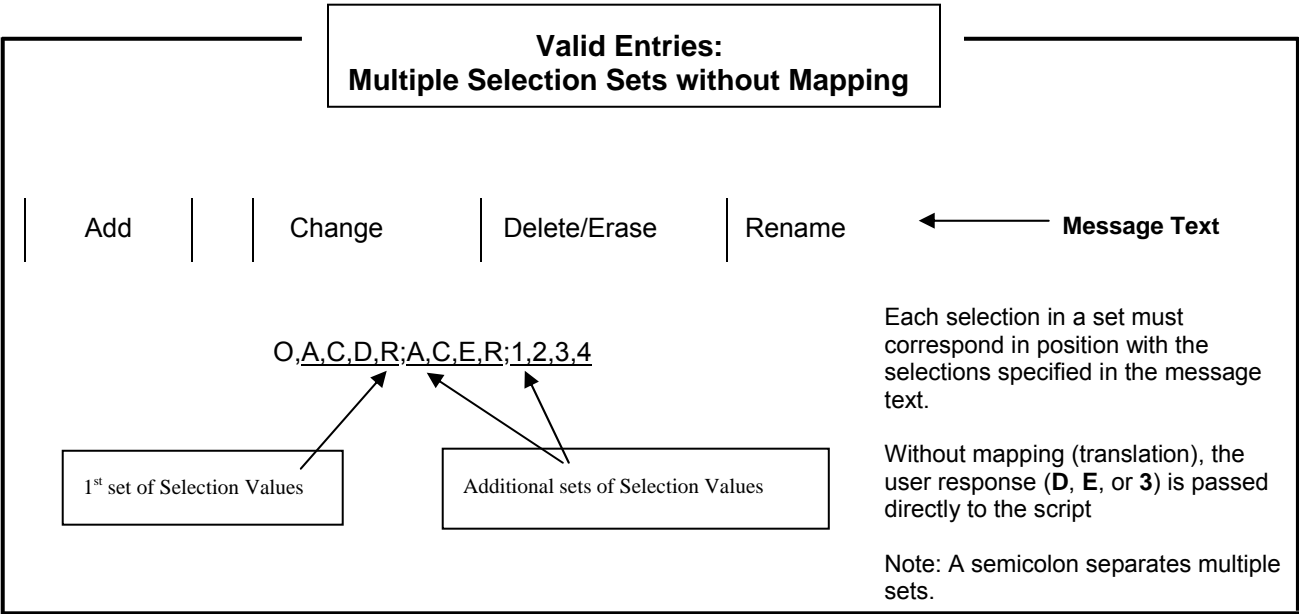

HELP

Dictionary-IV provides an on-line help system, which includes a dictionary, Help Editor, and advanced help window processing.

If you are operating in a Multi-Language environment, see Multi-Language in the Dictionary-IV Administrator Guide.

In Dictionary-IV, or any other Thoroughbred product, press **F6** at any message, data entry field, menu, or screen to get a detailed explanation of what you should do next and what options are available.

The Dictionary-IV help system has been created with Dictionary-IV; likewise, you can create help for your own Dictionary-IV applications. Dictionary help text can be created in Help definition or in any definition (except the Global Dictionary) which has a help field.

Following is a list of the places where help can be accessed:

- Help definition maintenance.
- Data Name attributes in Format definition.
- Header and menu selection specifications in Menu definition.
- Message dictionary maintenance (except prompt/constant messages).
- An option is provided to modify existing help whenever help is requested by the user. This option makes it very convenient to maintain and update help text. If the operator is defined as a developer, help can be created or modified when it is referenced. For more information, see Set Developer/User in the Dictionary-IV Administrator Guide.

Selection

Select **1-Edit** from the Dictionary-IV Development Menu or press **F1** from any Dictionary-IV menu. The system displays the Class pop-up menu:

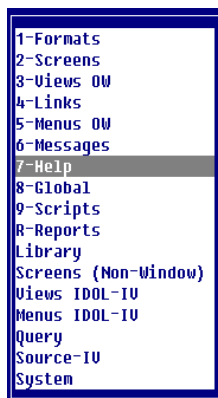

Select **7-Help**.

Help

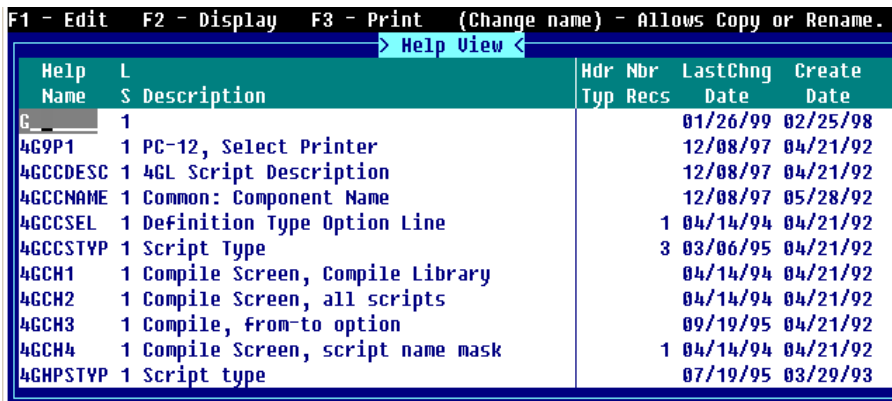

The screenshot shows a window titled "Help View" with a menu bar containing "F1 - Edit", "F2 - Display", "F3 - Print", and "(Change name) - Allows Copy or Rename.". The window displays a table with the following columns: Help Name, L, S, Description, Hdr Typ, Nbr Recs, LastChng Date, and Create Date. The first row is highlighted in green.

Help Name	L	S	Description	Hdr Typ	Nbr Recs	LastChng Date	Create Date
G_		1				01/26/99	02/25/98
4G9P1	1		PC-12, Select Printer			12/08/97	04/21/92
4GCCDESC	1		4GL Script Description			12/08/97	04/21/92
4GCCNAME	1		Common: Component Name			12/08/97	05/28/92
4GCCSEL	1		Definition Type Option Line		1	04/14/94	04/21/92
4GCCSTYP	1		Script Type		3	03/06/95	04/21/92
4GCH1	1		Compile Screen, Compile Library			04/14/94	04/21/92
4GCH2	1		Compile Screen, all scripts			04/14/94	04/21/92
4GCH3	1		Compile, from-to option			09/19/95	04/21/92
4GCH4	1		Compile Screen, script name mask		1	04/14/94	04/21/92
4GHPSTYP	1		Script type			07/19/95	03/29/93

Components of Help View

The Help View is composed of two parts: header information and help editor.

Help View Header Information

The help header information provides the specifications for the Help definition. These fields are used to identify the help module in the System Dictionary and to define the help size and display position.

You may enter the following information:

Help Name

Type from 3 to 8 alphanumeric characters for the name of this definition and press **Enter**. This field is mandatory.

Characters one and two are the Library name. Characters three through eight are the help name.

For more information, see Class definition in this document, which provides a file naming convention you may implement.

LS

For internal use.

Description

Type up to 30 alphanumeric characters for the description of this help definition and press **Enter**. This field is optional.

Header Type (Hdr Typ)

This field controls the use of the screen description in the window's top border.

Select one of the following:

- blank** Screen description does not appear in the window title area.
- C** Screen description is centered in the top border of the screen's window.
- R** Screen description is right justified in the top border of the screen's window.
- L** Screen description is left justified in the top border of the screen's window.

The default is **blank**.

Number Records (Nbr Recs)

Specifies the number of records used to create a data file. Valid entries range from 0 to 2, 147,483,647. The default value is **300** records. To specify an auto expanding direct or sort file, set the file type to **I** and the number of records to **0**.

Last Change Date

Displays the date of the last change to the selected Help.

Create Date

Displays the date of creation of the selected Help.

Help Editor

Once you complete the header information and press **Enter** at the last field, the help Editor displays. The window displays according to the size, position, and border code you specify.

The help editor is a Text Editor. It allows you to cut and paste, text, and perform search and replace. For more information, see Text Editor in the Dictionary-IV User Guide.

Using the Help Editor

Window help allows you to create Simple help Text, Indexed help, Pop-up Menu help, and Function Key help.

Simple Help Text

Type the text characters and/or graphic characters exactly as you want them to be displayed in the window. Remember **Page Up** and **Page Down** will toggle between display attributes and **F15** allows you to select display attributes, to select colors, and to toggle between character and graphic modes. The operator will view the text as entered.

F15 - You may toggle Reverse Video, Background, Underline, Blink, Graphic, and Color on and off from this option. Once you make your selections select **<Execute>**. These terms are defined in the Screen definition. The color attributes cannot be changed if the ability to save the color attributes has been disabled. Once this feature has been disabled, color attributes will be lost when the window is saved. If color text is saved on a non-color terminal, color attributes will be lost when the window is saved.

Example:

Type the following in the Help Editor:

Please enter the customer number in the space indicated by the underscore characters.

Substitution Values

Characters in the help text (substitution text) can be replaced by values (substitution values) passed into 8HELP. This is only available from the Dictionary-IV API 8HELP. For more information, see the Thoroughbred Basic Reference Manual.

Example:

**/D - /T
TERMINAL ID:xx**

This displays the following for the operator:

**10/18/96 - 08:45
Terminal ID:T0**

The text to be replaced must be a unique pattern of characters. In the example the text characters to be replaced are ID, IT, and xx. If the first character of the characters to be replaced is an I then replacement characters will be inserted into the text. Otherwise an overlay of replacement characters will be done.

When the insert mode is specified, text will be truncated when it exceeds the window width.

An example of the substitution parameter string is as follows.

```
HELPTXT$="/Id/"+D$+";It/"+T$+";xx/"=FID(0)
```

The first byte must be / or \ indicating the string contains substitution values to be evaluated. This is also the delimiter used to separate the substitution text and the substitution values. Multiple substitution strings must be separated by a ; (semi-colon).

Printer Control Commands

These are commands imbedded in the text. Each command must start on the left margin and must be on its own line. Command lines are removed when the help is displayed or the text is printed.

.HON Enables heading (default).
.HOFF Disables heading.
.E Unconditional eject.
.EN Eject if n lines not remaining on the page.
.Sn Space n lines.

Indexed Help

The first line in the help Index module must be `.HI.` to indicate this type of module.

```
.HI.num-disp-char,num-disp-lines,strt-col,strt-row HELP=x
text1...LLDDDDD1
text2...LLDDDDD2
text3...LLDDDDD3
```

`.HI.` defines this as a Help Index.

`num-disp-char` is the number of display characters per line.

`num-disp-lines` is the number of display lines.

`strt-col` is the starting column of the window.

`strt-row` is the starting row of the window.

`text` is the text that displays in the window.

`LLDDDDD` is the name of the help module that displays when the line is selected. The position of the help name is beyond the specified display characters per line.

`x` is a 3 to 8 alphanumeric character help code that displays when **F6** is pressed from the view.

Example:

```
.HI.9,3,0,10
Orders...LLHELP1
Invoices...LLHELP2
Specials.LLHELP3
```

This defines a help Index of 3 lines with 9 characters in each line. The window starting position is column 0 line 10. Orders, Invoices, and Specials appear in the window as text. Line 1 (Orders) displays help module LLHELP1, Line 2 (Invoices) displays help module LLHELP2, and Line 3 (Specials) displays help module LLHELP3. No help is defined from this view.

Pop-up Menu Help

A pop-up menu allows you to define a selection window. The first line in the pop-up menu must be `.HM.` or `.MN.` to indicate this type of module.

Pop-up menus are used with the 8MENU Dictionary-IV API (but are not limited to it). Returning selection values only apply when used with 8MENU. For more information about Dictionary-IV APIs, see Thoroughbred Basic Reference Manual.

Simple Pop-up Menu Returning a Selected Value

.HM.num-disp-char,num-disip-lines,strt-col,strt-row,\HELP=x	
Add.....	AHELP=HELPA
Change..	C
Delete....	D
Inquiry...	\HELP=HELP\CALL=PROGI

This displays the following for the operator:

Add.....
Change..
Delete....
Inquiry..

Optional parameters are displayed in background.

Parameters for a given line item can be continued onto one or more lines without affecting the display of the pop-up menu by using continuation character which is the colon (:). It must be in column 0 and must be in normal video/background. With the cursor in column 0, press **F11**, the continuation character will be inserted (see the last example in this section).

Menu Parameter

.HM. defines this as a pop-up menu (can also use **.MN.**).

num-disp-char is the number of display characters per line.

num-disp-lines is the number of display lines.

strt-col is the starting column of the window.

strt-row is the starting row of the window.

opt is the option that displays in the window.

a is the value to be returned when the line is selected. Return values can be variable length, leading and trailing spaces are ignored.

! is the supplied terminator. When using the default terminator (\) it is not required in the menu parameter list. When specifying a terminator, it must be used as shown. It must be in the menu selection line.

HELP=x is a 3 to 8 alphanumeric character help code that displays when **F6** is pressed from the view.

Option Definition

- Add** When selected, the value A will be returned in the menu selection variable of the 8MENU call variable list. **F6** will display help module HELPA, then return to the menu.
- Change** When selected, the value C will be returned in the menu selection variable of the 8MENU call variable list. **F6** will display the default help module HELPNAME, then return to the menu.
- Delete** When selected, the values or D will be returned in the menu selection variable of the 8MENU call variable list. **F6** will display the default help module HELPNAME, then return to the menu.
- Inquiry** When selected, the public program PPROGI will be called using the following CALL list:
CALL "PPROGI", PPA\$[ALL],]SYSV\$
The string array PPA\$[ALL] is the only way to pass arguments to and from 8MENU and then to public program specified by CALL=name. If public ENTER list does not match the above call list the program is assumed to be a public type containing an ENTER PUBLIC command which contains no parameters.

Returning from the public program does not exit 8MENU. To exit either press **F4** or select another menu option that does not call a public program.

F4 on a selection that calls a public program will return the selected value. In this example the value of I will be returned in the menu selection variable of the 8MENU call variable list. **F6** will display the help module HELPI then return to the menu.

Pop-up Menu Invoking a Network of Menus, Help, and Commands

.MN.num-disp-char,num-disp-lines,strt-col,strt-row,\HELP=x	
Menu.....	.MN.NAME,CC\HELP=HELP1
Index Help..	.HI.NAME\HELP=HELP2
Help.....	.H.NAME
UNIX shell...	.US.shell command

This displays the following for the operator:

Menu.....
Index Help..
Help.....
UNIX shell

Menu Parameter

- `.MN.` defines this as a pop-up menu (can also use `.HM.`).
- `num-disp-char` is the number of display characters per line.
- `num-disp-lines` is the number of display lines.
- `strt-col` is the starting column of the window.
- `strt-row` is the starting row of the window.
- `opt` is the option that displays in the window.
- `a` is the value to be returned when the line is selected. Return values can be variable length, leading and trailing spaces are ignored.
- `!` is the supplied terminator. When using the default terminator (`()`) it is not required in the menu parameter list. When specifying a terminator, it must be used as shown. It must be in the menu selection line.
- `HELP=x` is a 3 to 8 alphanumeric character help code that displays when **F6** is pressed from the view.

Option Definition

- Menu** is a pop-up menu to be processed. When selected, 8MENU will call 8MENU to process the supplied pop-up menu.
- Index Help** is an indexed help module to be processed. When selected 8MENU will call 8HELP to process the supplied index help module.
- Help** is a simple help module to be processed. When selected 8MENU will call 8HELP to process the supplied help module. You may use `.HI.` to define this line.
- UNIX shell** is a UNIX or Linux shell command to be processed. When selected, the supplied system command will be processed. The UNIX or Xenix shell command, for example, `ps -ef |pg.`

When a sub menu or help module is terminated with an **Enter**, the 8MENU will exit to the root program, which initiated the call to 8MENU, returning the selected value from the lowest level pop-up menu. When a sub menu or help module is terminated with an **F4**, 8MENU will exit one level, returning to the previous pop-up menu or help module.

PREV= to preview

This example illustrates the use of `PREV=` to preview the corresponding sub menus when scrolling through a pop-up menu.

```
.MN.num-disp-char,num-disp-lines,strt-col,strt-row,\HELP=x
Selection 1 .MN.NAME1\HELP=HELP1\PREV=NAME1
Selection 2 .MN.NAME2\HELP=HELP2
:\PREV=NAME2 50,13,BORDER=LGIBORDERATR=NVI
```

```
: SELECTATR=NV
Selection 3 .MN.NAME3\PREV=NAME3 50,15,BORDER=LGI
:BORDERATR=NVSELECTATR=NV
:\CALL=PUBLIC3
:\HELP=HELP3
Selection 4 .MN.NAME4\PREV=NAME4,,
:BORDER=LGI BORDERATR=NV:SELECTATR=NV
```

This displays the following for the operator:

```
Selection 1
Selection 2
Selection 3
Selection 4
```

The syntax definitions are the same as in the previous examples with the following exceptions:

PREV= is the name of the pop-up menu to display when the lightbar is scrolled onto that menu selection line. The sub menu is always displayed with FUNC\$="x": display no scroll, no action on exit.

50 is the column for the sub menu window display spacing. The comma following the column position is required syntax even when the value is not supplied. (See selection 4 in the above example.) If not specified, the column position from line of the sub menu will be used.

15 is the row for the sub menu window display. The comma following the row position is required syntax even when the value is not supplied. (See position 4 in the above example.) If not specified, the row position from the line of the sub menu will be used.

: is the continuation line character. With the cursor in column 0, press **F11**.

Window Create Attributes

These are attributes to be used when the sub menu window is displayed. At the time the window is created, the attributes from the parameter list are compared to the Dictionary APIs (Public Programming Services) default values.

The default values will be used for all attributes not supplied in the parameter list. The syntax for the Window Create Attribute list must follow the format specified by the Window Create directive.

The vertical bar (|) or the separator character defined by SEP=character, must be used to chain multiple attributes. See the Window Create directive for details on the required syntax.

The Window Create directive requires the use of quotes around the attribute keyword and values. Quotes should not be used in the sub menu parameter list.

Function Key Help

The first line in the help Index module must be .HF. to indicate this type of module.

.HF.LLHLP F1 - Customers F2 - Inventory F3 - Sales F5 - Other
--

.HF. indicates a function key type help module.

LLHLP is the name of the help module prefix. It can be from 3 to 6 alphanumeric characters in length. The prefix combined with the function key value build the name of the help module to be displayed then the function key is pressed. In this example, pressing **F3** would display a help module named LLHLP03.

GLOBAL SYSTEMS DEFINITION

The **Global** option on the Dictionary-IV menu allows you to access the OPENworkshop global cross-reference system. To use the system you first create cross-reference tables containing the references you need, then view them. A new set of tables can be created whenever you wish.

Global Option

Select **1-Edit** from the Dictionary-IV Development Menu or press **F1** from any Dictionary-IV menu. The system displays the Class pop-up menu:

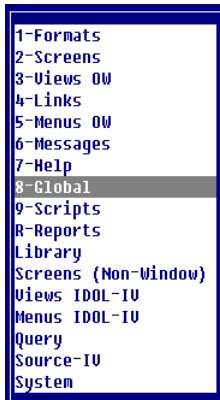

Select **8-Global**. When you first enter this system you must create the cross-references you require. The system displays the following:

Global Cross Reference: <F1> View <F3> or <F5> Create <F16> Report

Global Systems Definition				
Sys Id	Description	Dict-IV Libraries	Method Libraries	Created Date
E	Example Application	1	0	02/27/98

Press **Line Insert** to add a new line to the Global Systems definition, enter the System ID and description.

Global Cross Reference: <F1> View <F3> or <F5> Create <F16> Report

Global Systems Definition

Sys Id	Description	Dict-IV Libraries	Method Libraries	Created Date
		0	0	02/05/99
E	Example Application	1	0	02/27/98

In the Dictionary-IV Libraries column press the **Enter** key and type the names of the libraries you wish to add to the list shown. Note that more than one library can be specified in this list. Enter the Library. Press **F2** to display the Library View:

Dict-IV Libraries

Press the **Tab** key. Press the **Enter** key. Use the same procedure to add the Method libraries column, press the **Tab** key, and then press the **Enter** key to add the Method libraries.

Move the cursor to the System ID column and select the **Create (F5)** option to build the cross-references.

You may also press **F16** to create a report:

Global XREF - Data Names		
Example		
Data Name	Type/Used	Type/Used
CUST-ADDRESS	F-OEFCUST	F-OEFCUSTX
	S-OESCUST	S-OESCUST1
	U-OEUCUST1	U-OEUCUST2
	U-OEUCUSTX	U-OEUCUSTZ
CUST-CITY	F-OEFCUST	F-OEFCUSTX
	B-OELCUST	B-OELCUST2
	S-OESCUST	S-OESCUST1
	U-OEUCUST	U-OEUCUST1
	U-OEUCUST2	U-OEUCUSTX
	U-OEUCUSTZ	r-OERINUD
CUST-CODE	F-OEFCUST	F-OEFCUSTX
	F-DEFINUD	F-DEFINUH
	M-OEM1	S-OESCUST
	S-OESCUST1	U-OEUCUST
	U-OEUCUST1	U-OEUCUST2
	U-OEUCUSTX	U-OEUCUSTZ

Enter window control or <CR> to continue.

Once the cross-references are built, press **F1** in the **Sys Id** column to explore the cross-reference information that is available through the following WhereUsed menu:



Each option allows you to select a class or other set of system components to review. For example, the **FORMAT** option displays all formats in the system and shows where they are used. Select **FORMAT** to produce the **FORMAT Where Used View**, for example:

FORMAT Where Used View		
Format Name	Used By	Type
OEFCUST	OEFCUST	Link
OEFCUST	OELCUST	Link
OEFCUST	OELCUST1	Link
OEFCUST	OELCUST2	Link
OEFCUST	OESCUST	Scrn
OEFCUST	OESCUST1	Scrn
OEFCUST	OEUCUST	View
OEFCUST	OEUCUST1	View
OEFCUST	OEUCUST2	View
OEFCUST	OEUCUSTX	View
OEFCUST	OEUCUSTZ	View

This view shows where every Format in the selected system is used, and the type of system component that uses it. Note that all of the classes themselves can be displayed or edited from this where-used view. Move the cursor to the required item and select **Edit (F1)** or **Display (F2)**.

F1 to Edit

Fld Num	Data Name	Field Size	K F Help	V S Code	Y P D N E	U D D S M B A A
Num	-----Data Name-----	Field Size	Y S Code	N D T T T	U E R C S P P U	
1	CUST-CODE	6	Y N CUS01	N 0 0 0 0		X X X
2	CUST-CONTACT	25	N N CUS02	N 0 0 0 2		X X X
3	CUST-NAME	30	N N	N 0 0 0 2		X X X
4	CUST-ADDRESS	30	N N	N 0 0 0 0		
5	CUST-CITY	25	N N	N 0 0 0 2		
6	CUST-STATE	2	N N	N 0 0 0 3		X X
7	CUST-ZIP	10	N N	N 0 0 0 0		
8	CUST-PHONE	10	N N	N 4 0 0 3		
9	CUST-DISC	5.2	N N	N 0 0 1 0	X	
10	CUST-CALMT	5.0	N N	N 0 0 1 0		
11	CUST-STC	2	N N	N 0 0 0 0	X	
12	SR-CODE	2	N N	N 0 0 0 3	X	X X
13	CUST-COMMENTS	1	N N	N 6 0 0 0	X	
14	CUST-SALES	11.2	N N CUS14	N 0 0 0 0		X X

F2 to Display

```

1 CUST-CODE      6      N CUS01  Y 0 0 0 0 N      1
...Special Prompt:
  UP[1]
.....Pre Process:
CONNECT(1) REPORT OERCUST;
CONNECT(2) METHOD OEZSTST START;
CONNECT METHOD OEZSTST0
.....Post Process:
CONNECT METHOD OEZSTST1
2 CUST-CONTACT  25      N CUS02  N 2 0 0 0 N      7
...Special Prompt:
  UP[6];
  SP[8]
.....Pre Process:
CONNECT(2) METHOD OEZSTST4 PASSED-PARM
...Post Process:
CONNECT METHOD OEZSTST4 POST-TEST
  
```

The **GLOBAL** option of the WhereUsed menu shows where Data Names are set or used:

- WhereUsed
- FORMAT
- VIEW
- SCREEN
- LINK
- MENU
- HELP
- REPORT
- QUERY
- METHOD
- FILE
- GLOBAL**

Select **GLOBAL** to display the Global Dataname Where Used menu:

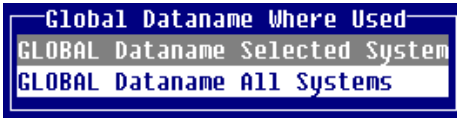

Selecting the highlighted option displays the following menu:



As before, you can review or change the definitions of items from these views. These cross-reference views are extremely flexible and powerful as can be seen from the following examples:

The **Used By Format** option shows which formats contain a definition of which Data Names throughout the application.

Data Name	Ky	Format
CUST-ADDRESS	_	DEFCUST
CUST-ADDRESS	_	DEFCUSTX
CUST-CITY	_	DEFCUST
CUST-CITY	_	DEFCUSTX
CUST-CODE	Y	DEFCUST
CUST-CODE	Y	DEFCUSTX
CUST-CODE	_	DEFINUD
CUST-CODE	_	DEFINUH
CUST-COMMENTS	_	DEFCUST
CUST-COMMENTS	_	DEFCUSTX
CUST-CONTACT	_	DEFCUST
CUST-CONTACT	_	DEFCUSTX

The **Used By Method** option shows all Data Names that are used by methods, and whether the method simply read the data name or may also set its value.

The **Used By Data Name** option shows Data Names that are set or used from other Data Names. Typically these uses are to be found in Data Name pre-process or post-process definitions. The normal order of presentation of the format name and Data Name in the left hand column of this display is reversed, so that Data Names are listed in alphabetically sorted order.

```

C 7 INU-LPRICE      8.2      N      N 0 1 0 0 N      32
.....Security:
  3,0

```

Data Name	Used/Set By Dataname	Set/Used
INU-LPRICE.OEFINUD	OEFINUD.ITEM-CODE	S
INU-NUM.OEFINUH	OEFINUH.INU-AMOUNT	U
ITEM-CODE.OEFINUD	OEFINUD.ITEM-CODE	S
ITEM-CODE.OEFINVEN	OEFINVEN.ITEM-SALES	U
ITEM-CODE.OEFINUN	OEFINUD.ITEM-CODE	U
ITEM-CODE.OEFINUN	OEFINUN.ITEM-CODE	U
ITEM-CODE.OEFINUN	OEFINUN.ITEM-SALES	U
ITEM-PRICE.OEFINUN	OEFINUD.ITEM-CODE	U

The **Used By All** option shows all uses of Data Names by all classes and methods in the application.

```

C 4 CUST-ADDRESS   30      N      N 0 0 0 0 N      62

```

Data Name	K	Set/Used	Used Type	Used By
CUST-ADDRESS	y	U	Fmt	OEFICUST
CUST-ADDRESS	-	U	Fmt	OEFICUSTX
CUST-ADDRESS.OEFICUST	-	U	Scrn	OESCUST
CUST-ADDRESS.OEFICUST	-	U	Scrn	OESCUST1
CUST-ADDRESS.OEFICUST	-	U	View	OECUST1
CUST-ADDRESS.OEFICUST	-	U	View	OECUST2
CUST-ADDRESS.OEFICUST	-	U	View	OECUSTX
CUST-ADDRESS.OEFICUST	-	U	View	OECUSTZ
CUST-CITY	-	U	Fmt	OEFICUST
CUST-CITY	-	U	Fmt	OEFICUSTX
CUST-CITY.OEFICUST	-	U	Link	OELCUST